

London Electronics Limited

Thorncote Road, Near Sandy, Bedfordshire SG19 1PU
Tel +44(0)1767 626444 Fax +44(0)1767 626446
www.london-electronics.com help@london-electronics.com

Large digit load / weight indicator / controller Fusion-L 6 digit version

Connection details, scaling and general information

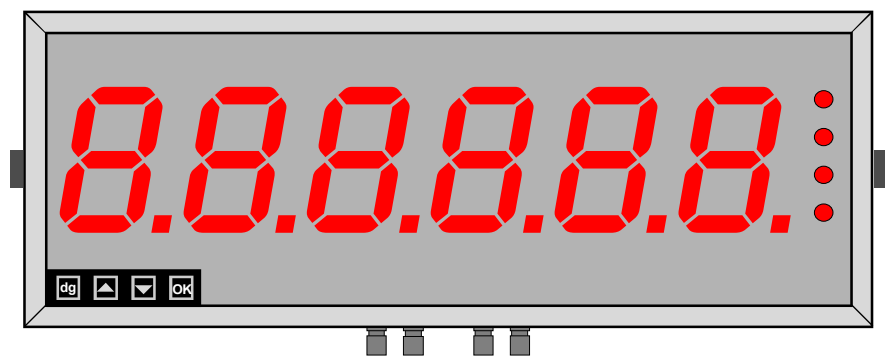

Caution: There is a risk of electrical shock if this instrument is not properly installed



Caution: Risk of danger: Read the whole manual before you install this display

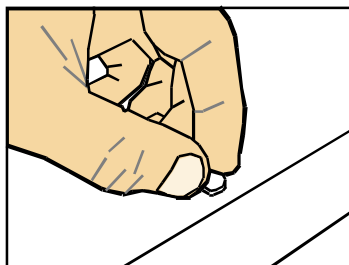

Rear case screws - please note

The rear panel is held in place with finger-screws, which only need to be gently tightened.

Do not use tools to tighten or loosen the screws, as this could cause damage to the internal threads.

Software version F00.21

Document Ref:pm65\manuals\Fusion_L Revision:19 Dated: 22 August 2011

Warranty

We warrant our products against defects in materials or workmanship for a period of three (3) years from the date of purchase.

In the event of a defect during the warranty period, the unit should be returned, freight (and all duties and taxes) prepaid by the Buyer to the authorised distributor from where the unit was purchased.

The Distributor, at its option, will repair or replace the defective unit. The unit will be returned to the Buyer with freight charges prepaid by the distributor.

LIMITATION OF WARRANTY

The foregoing warranty shall not apply to defects resulting from:

1. Improper or inadequate maintenance by the buyer.
2. Unauthorised modification or misuse.
3. Operation outside the environmental specification of the product.
4. Mishandling or abuse.

The warranty set forth above is exclusive and no other warranty, whether written or oral is expressed or implied. We specifically disclaim the implied warranties of merchantability and fitness for a particular purpose.

EXCLUSIVE REMEDIES

The remedies provided herein are the buyer's sole and exclusive remedies.

In no event shall we be liable for direct, indirect, incidental or consequential damages (including loss of profits) whether based on contract, tort or any other legal theory.

Contents

Warranty	2
Warnings	4
Introduction	5
General Description	6
Suspension Mounting	7
Wall Mounting	8
Panel Mounting	9
Connections	10-11
Installation hints for best performance	12-13
Easy/Advanced menu mode	14
Language Selection	15
Display Brightness	16
Display Calibration Modes	17
Direct Calibration	18-19
Linearisation with Direct Calibration	20-21
Theoretical Calibration	22-23
Linearisation with Theoretical Calibration	24-25
Sensor Drift correction	26
Logic Input functions	27
Logic Input connections & Front Buttons	28
Factory defaults	29
Calibration Audit number	29
Signal Filtering / Averaging	30-31
Last Digit rounding	32
Scale Factor adjustment	33
Offset Adjustment	34
Menu Timeout adjustment	35
Reverse / Mirror display setting	36
Bootup Routine choices	37
Multi Memory MEM option	38
Error Codes	39
Output Options - installing	40
WEEE	41
Equipment Specifications	42
Record of Revisions	42
Loadcell Connection examples	43
Declaration of Conformity	44

Separate manuals for options

Alarm option settings	See Alarm manual *
Analogue output option settings	See Analogue manual *
Serial output option settings	See Serial manual *
Real Time Clock setting	See Serial manual *

* Need a manual urgently?

You can download manuals from our website

Warnings

Please carefully read this manual and all warnings. Install the display ONLY when you are sure that you've covered all aspects.



Where the product is intended for "UL" installations, removal or addition of option boards is not permitted.



Check that the model number and supply voltage suit your application before you install the display.



Connect the display according to current IEE regulations, IEC61010 & NFPA:70 National Electric Code in USA.



Power supplies to this equipment must have anti-surge (T) fuses rated at 1A for 230V supply, 2A for 110V, 5A for 48VAC supply or 10A for DC supplies in the range 11-30VDC.



Don't touch any circuitry after you have connected the display, because there may be lethal voltages on the circuit board.



Do not apply power to the display if its case is open.



Only adjust on-board switches or connections with the power turned off



Make sure all screw terminals are tight before you switch the meter on.



Only clean the display's case and window with a soft damp cloth. Only lightly dampen with water. Do not use any other solvents.

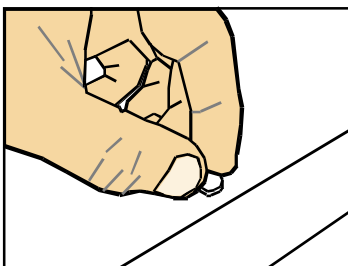

Rear case screws - please note

The rear panel is held in place with finger-screws, which only need to be gently tightened.

Do not use tools to tighten or loosen the screws, as this could cause damage to the internal threads.

**Safety FirstDon't assume anything..... Always double check.
If in doubt, ask someone who is QUALIFIED to assist you in the subject.**

Introduction

Please contact us if you need help, if you have a complaint, or if you have suggestions to help us improve our products or services.

If you contact us about a product you already have, please tell us the full model number and serial number, so that we can give you accurate and fast help.

This product has a 2 year warranty. We will put right or replace any display which is faulty because of bad workmanship or materials. This warranty does not cover damage caused by misuse or accident.

If you return a unit for repair, please include a detailed description of the problem, and the name of a contact who we can refer to for any questions. Please mark for the attention of the QA Department.

IMPORTANT

If this equipment is important to your process, you may want to buy a spare to cover possible failure or accidental damage in the future.

This is because during factory shutdown periods, you may have to wait several weeks for an equivalent replacement, or we may have no stock at the time you urgently need it.

You may also need to pay extra carriage charges if you want a fast, guaranteed courier service. Warranty repairs or replacements are usually returned with a standard courier service.

We do not offer compensation for losses caused by failure of this instrument.

If you do not agree with these conditions, please return this item in unused condition, in its original packaging and we will refund the purchase price, excluding any carriage paid.

We thought you'd prefer to know about possible delays and extra charges now, rather than during a panic. A spare unit could help to avoid these issues.

We always try to improve our products and services, so these may change over time. You should keep this manual safely, because future manuals, for new designs, may not describe this product accurately.

We believe these instructions are accurate, and that we have competently designed and manufactured the product, but please let us know if you find any errors.

General Description

This series of displays accepts industrial sensors to allow various physical measurements to be made, such as weight, temperature, pressure, humidity etc. Different models are available for different sensor types.

The main function of this series is to give a clear numeric readout of the variable being monitored. Most models include an excitation power output, to power the sensor directly.

Various digit heights are available, to suit the maximum viewing distance required in each installation. For every 10 metres of viewing distance required, use 1" of digit height.

Various optional output modules are also available to give alarm relay outputs, analogue output or digital communications, or any combination of these options.

Displays are programmed using front panel pushbuttons. The front panel buttons can be disabled. In addition, you can connect 4 remote wired pushbuttons to the display, so that you can make adjustments while the display is mounted in an inaccessible location.

Displays have three power supply options : 100-240 VAC, 48 VAC or 11-30 VDC

These displays must be installed fully assembled, and must be installed according to local electrical installation rules.

When properly installed, and provided they have been ordered with cable glands exiting the lower surface of the case, they provide ingress protection to IP65 / NEMA4X from all directions.

Safety



Caution: There is a risk of electrical shock if this display is not properly installed



Caution: Risk of danger: Read the whole manual before you install this display

Obey all safety warnings in this manual, and install the display according to local wiring and installation regulations. Failure to follow these guidelines may cause damage to the display, connected equipment, or may be harmful to personnel.

Any moving mechanical device controlled by this equipment must have suitable access guards to prevent injury to personnel if the display should fail.

Suspension Mounting dimensions

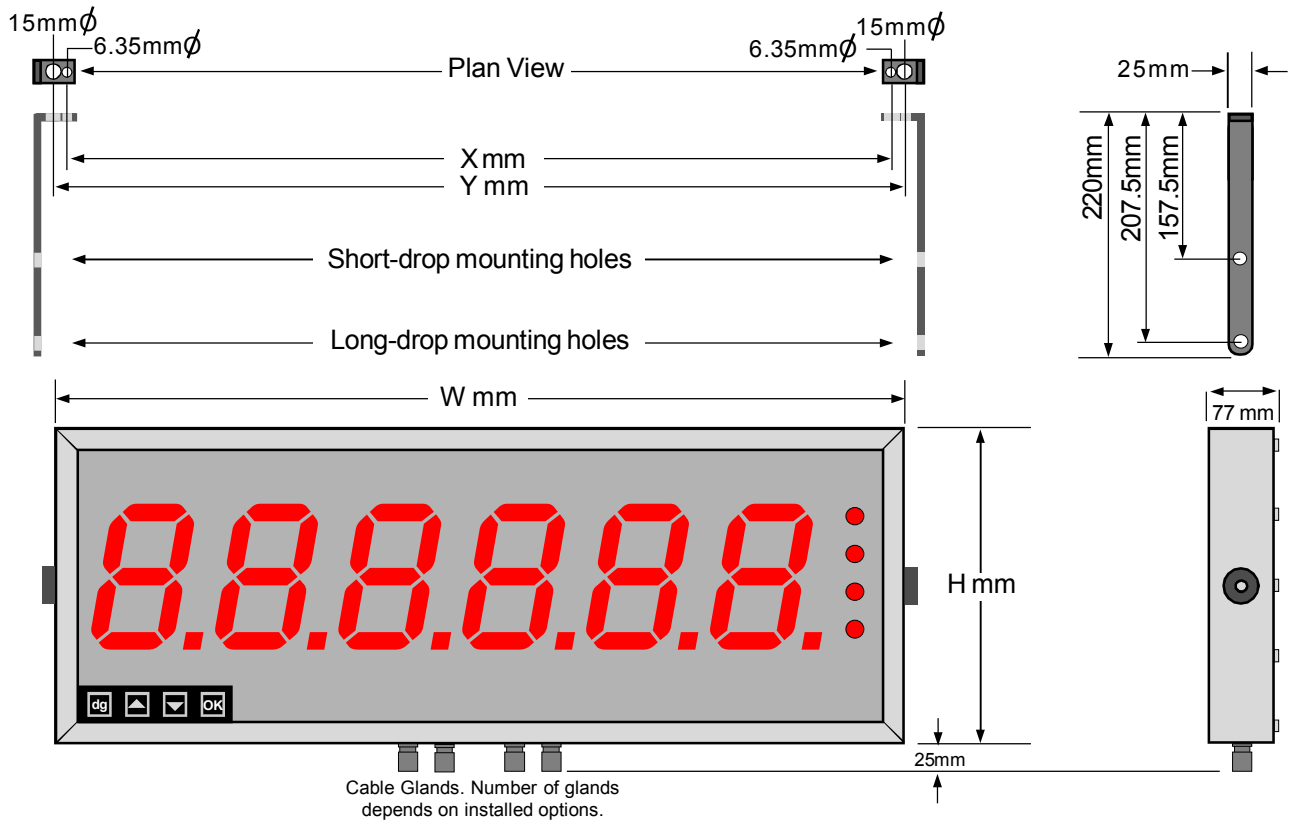

Detail showing bracket hardware fitting sequence

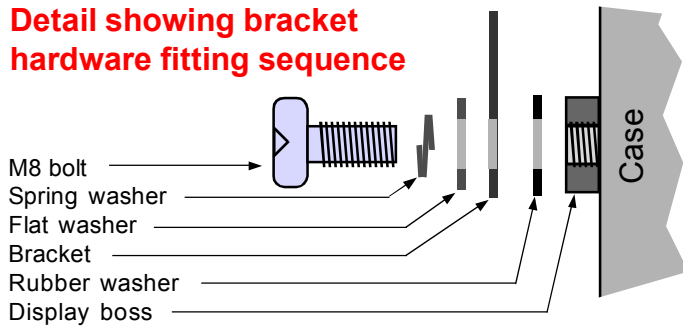

You can order these displays with the cable glands in the bottom surface (as shown) the rear, or top.

Rear glands allow you to mount the display on top of a cubicle, using the brackets shown.

Display Format	X mm	H mm	W mm	Y mm
2" 4 digit clock	245	154.5	291	275
2" 4 digit numeric	233.5	154.5	279.5	263.5
2" 6 digit clock	354	154.5	400	384
2" 6 digit numeric	330	154.5	376	360
4" 4 digit clock	407	195.5	453	437
4" 4 digit numeric	388	195.5	434	418
4" 6 digit clock	607	195.5	653	637
4" 6 digit numeric	570	195.5	616	600
6" 4 digit	534	246	580	564
6" 6 digit	774	246	820	804
8" 4 digit	704	290	750	734
8" 6 digit	1026	290	1072	1056
12" 4 digit	1004	408	1050	1034
12" 6 digit	1494	408	1540	1524
16" 4 digit	1322	515	1368	1352
16" 6 digit	1974	515	2020	2004

Wall Mounting dimensions

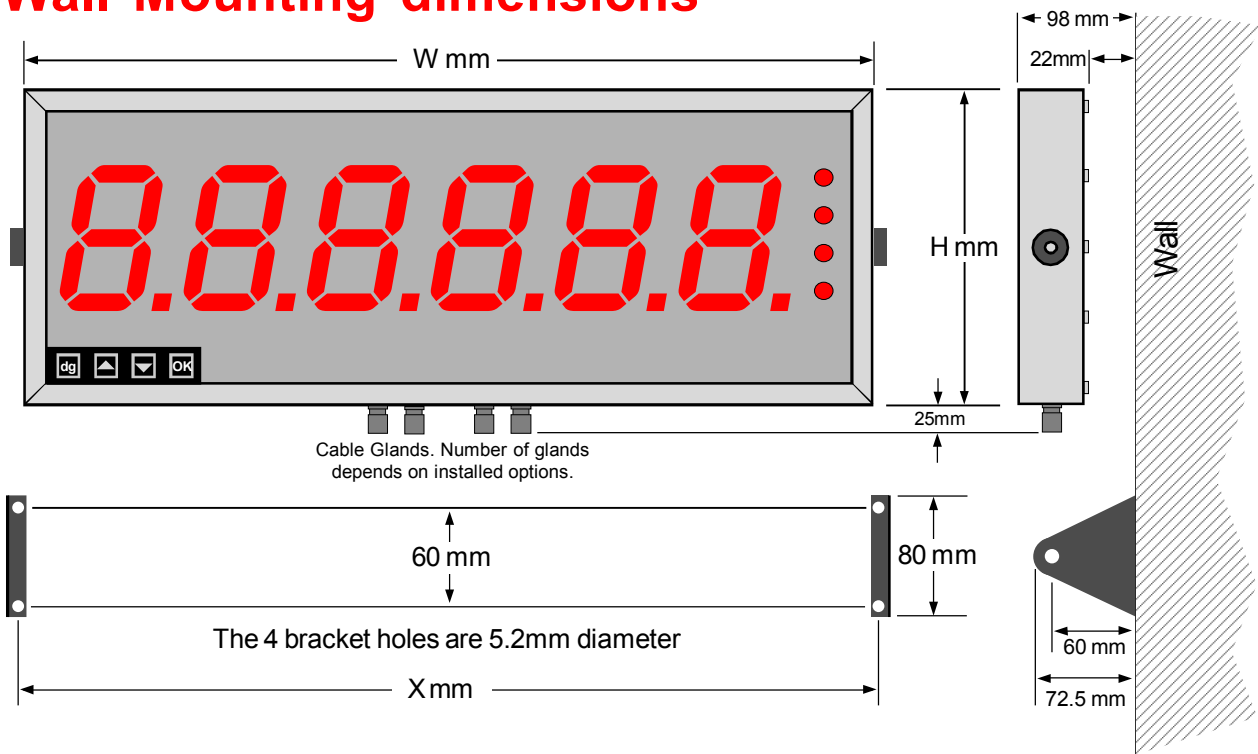

Detail showing bracket hardware fitting sequence

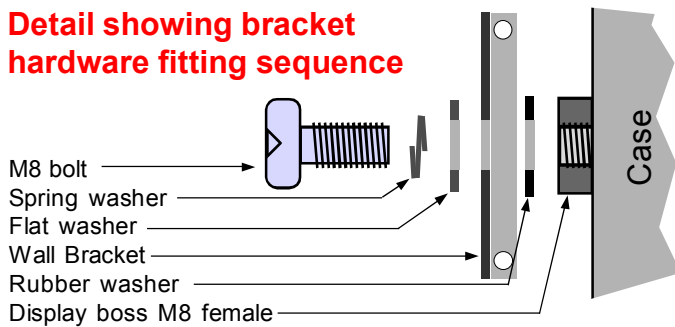

The side holes in the two brackets are 8.5mm dia. to accept M8 bolts.

Display Format	X mm	H mm	W mm
2" 4 digit clock	292	154.5	291
2" 4 digit numeric	280.5	154.5	279.5
2" 6 digit clock	401	154.5	400
2" 6 digit numeric	377	154.5	376
4" 4 digit clock	454	195.5	453
4" 4 digit numeric	435	195.5	434
4" 6 digit clock	654	195.5	653
4" 6 digit numeric	617	195.5	616
6" 4 digit	581	246	580
6" 6 digit	821	246	820
8" 4 digit	751	290	750
8" 6 digit	1073	290	1072
12" 4 digit	1051	408	1050
12" 6 digit	1541	408	1540
16" 4 digit	1369	515	1368
16" 6 digit	2021	515	2020

Panel mounting dimensions

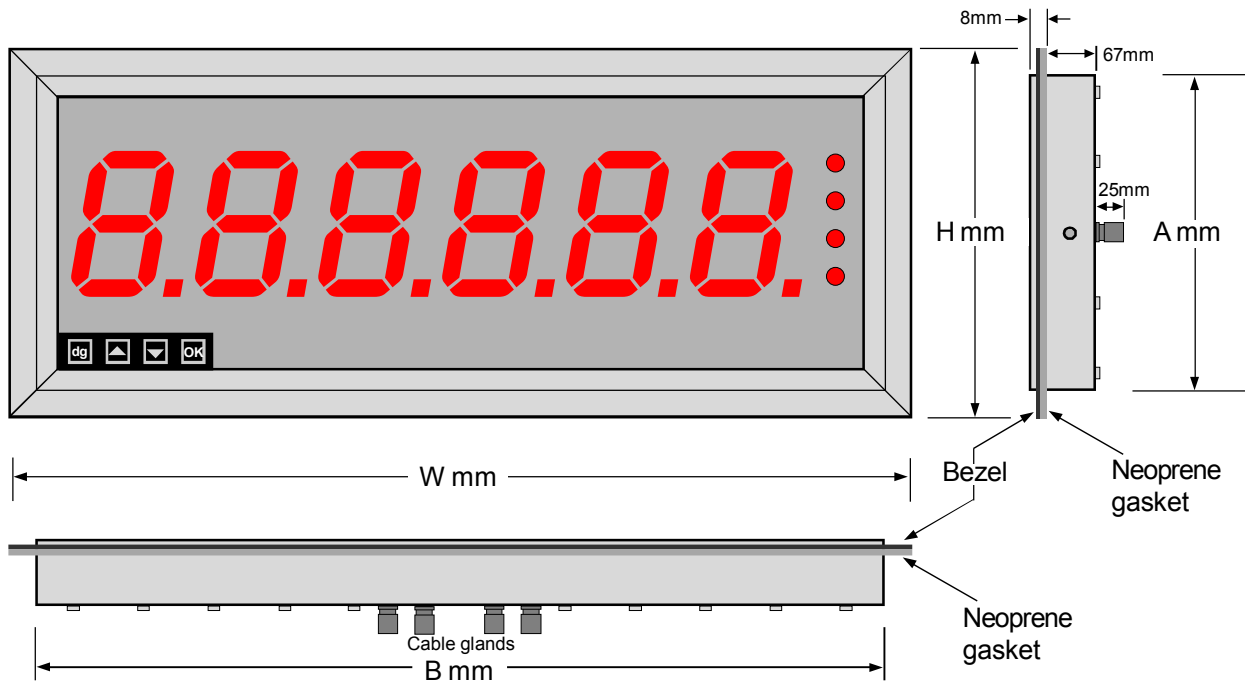

Detail showing bracket hardware fitting sequence

Panel cutout dimensions
 $A+3\text{mm}(h) \times B+3\text{mm}(w)$

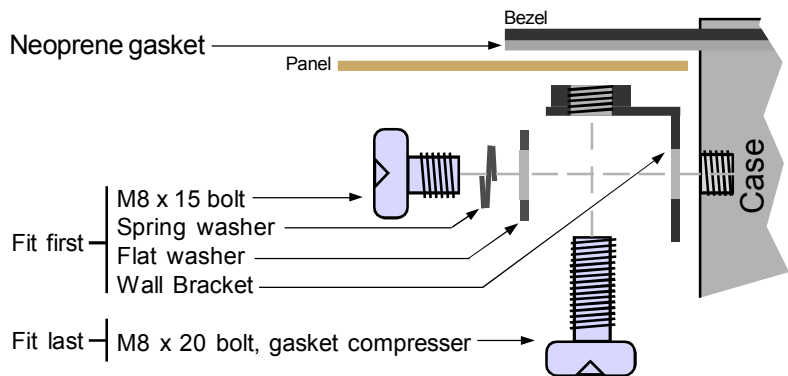

Display Format	H mm	A mm	B mm	Wmm
2" 4 digit clock	172.5	154.5	291	309
2" 4 digit numeric	172.5	154.5	279.5	297.5
2" 6 digit clock	172.5	154.5	400	418
2" 6 digit numeric	172.5	154.5	376	394
4" 4 digit clock	213.5	195.5	453	471
4" 4 digit numeric	213.5	195.5	434	452
4" 6 digit clock	213.5	195.5	653	671
4" 6 digit numeric	213.5	195.5	616	634
6" 4 digit	264	246	580	598
6" 6 digit	264	246	820	838
8" 4 digit	308	290	750	768
8" 6 digit	308	290	1072	1090
12" 4 digit	426	408	1050	1068
12" 6 digit	426	408	1540	1558
16" 4 digit	533	515	1368	1386
16" 6 digit	533	515	2020	2038

Connections



Warning:
Disconnect all power before removing the rear of the display

There is a wide range of possible locations for the input board, output board and power supply board/s. Their locations depend on the height of digits, number of digits, brightness of digits and any installed options. Because the permutation of possible locations is large, we will not describe the location of boards within the display, but simply identify the connectors and their functions on each board, below ...

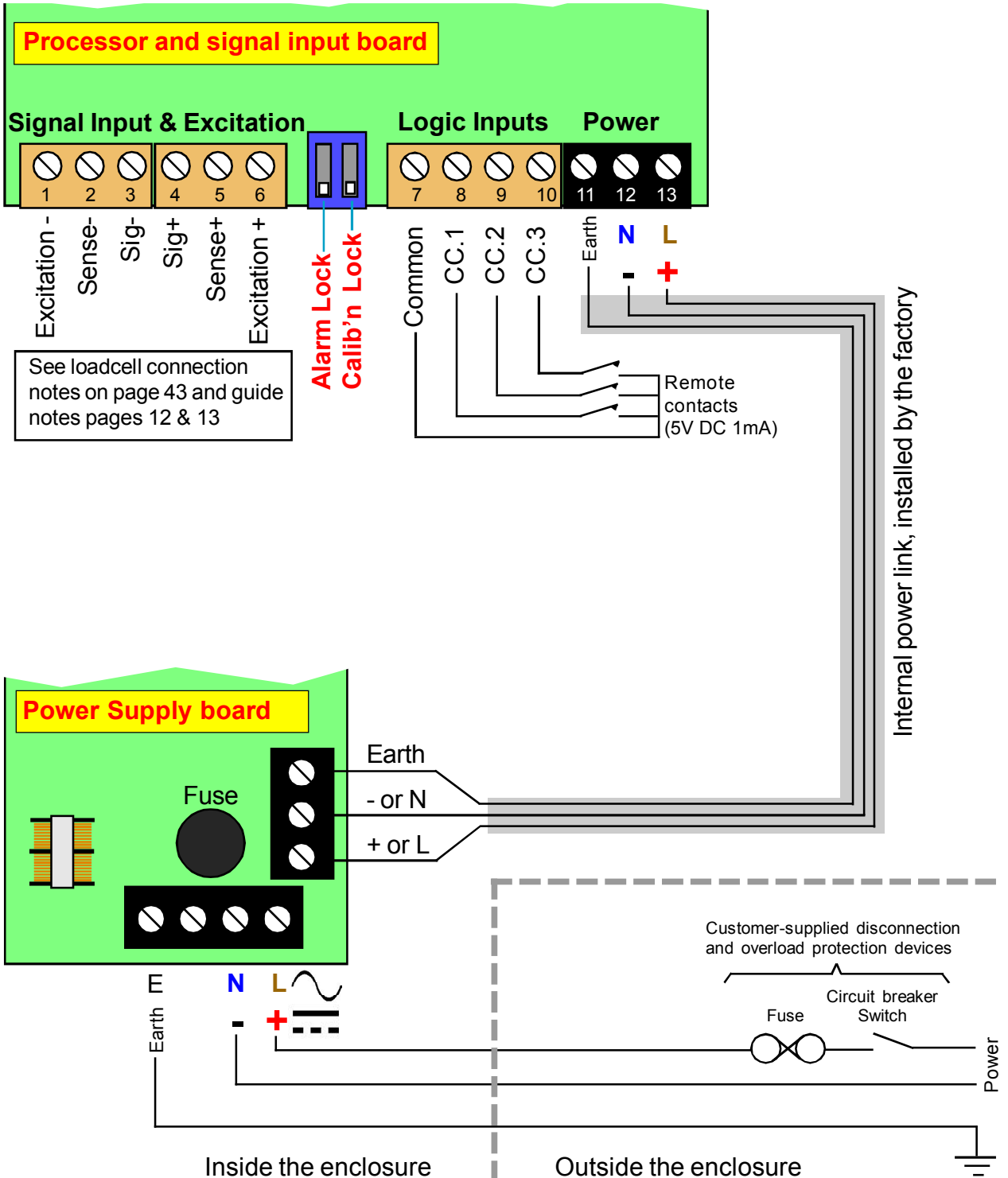
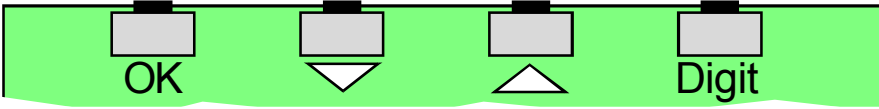

Connections

Warning:
Disconnect all power before removing the rear of the display

Connectors and options
Connectors may be present even if output options are not installed. Refer to rating label to see installed options.

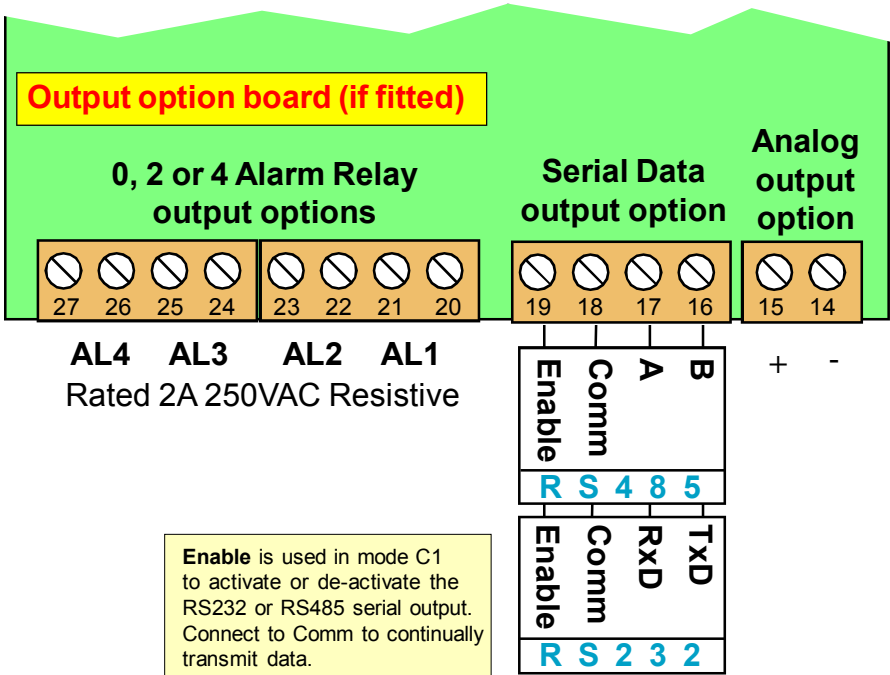

Remote programming button connector

On one of the display boards, you will find a 7 way connector, to which you can wire remote programming buttons, to allow adjustment of the display's settings when the display is inaccessible.

You can also enable or disable the display's front panel buttons, either by a remote contact closure, or by an on-board push-on jumper switch, which is located near to the remote button connector. When the contact is closed, or the push-on switch fitted, the front buttons are enabled.

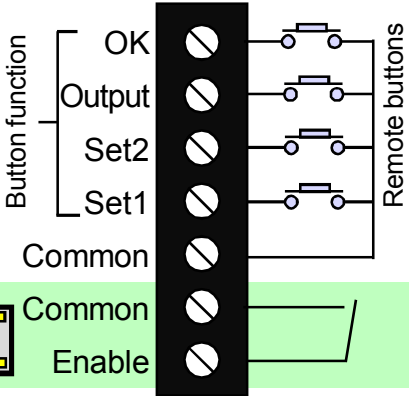

Close contact or fit jumper to enable front panel buttons

Display's front panel buttons enabled/disabled by jumper or connection

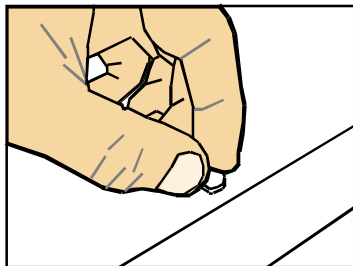

Rear case screws - please note

The rear panel is held in place with finger-screws, which only need to be gently tightened. **Do not use tools to tighten or loosen the screws, as this could cause damage to the internal threads.**

Installation hints for best performance

This section offers several suggestions which will help you get the best performance from your weighing system.

Loadcells create very small signals which can easily be corrupted by electrical noise. These steps will ensure you get the best possible performance from your meter.

1. Use good quality screened signal cable, with 3 twisted pairs. Belden 8777NH, Belden 9503 and AlphaWire 6010C are good choices, available from many electrical distributors.
2. Even if your loadcell is only a 4 wire device, we recommend you use 6 core cable between the display and the loadcell, and wire as shown in the diagram opposite. This will ensure that any resistance changes in your cabling, caused by changes in temperature, will be cancelled.
3. Each pair should be dedicated to a signal function as shown opposite, for maximum noise immunity. (One twisted pair for Excitation, one twisted pair for Sense, one twisted pair for Signal) This will ensure that any electrical noise induced in the cable is properly cancelled. Mixing functions carelessly amongst the twisted pairs can actually worsen noise performance.
4. The cable should be routed away from noisy wiring and devices such as power feeds from inverters, discharge-lighting cables, welder cabling etc, and should preferably be routed in a dedicated low voltage signalling/instrumentation conduit or cable tray.
5. Screened cable should be earthed at the display end only.
6. All wires and screens coming out of the screened cable should be kept as short as possible to minimise pickup of noise.
7. If you are using barriers, you should earth your screen as shown below, paying particular care that you do not earth both ends of any run of of cable. **NB** If using galvanic isolation barriers, connect 10K from terminal 2 to terminal 3 and 10K from terminal 3 to terminal 5 on the display's Sig. Input connector to maintain the input signal within the common mode range of the excitation sense circuit.

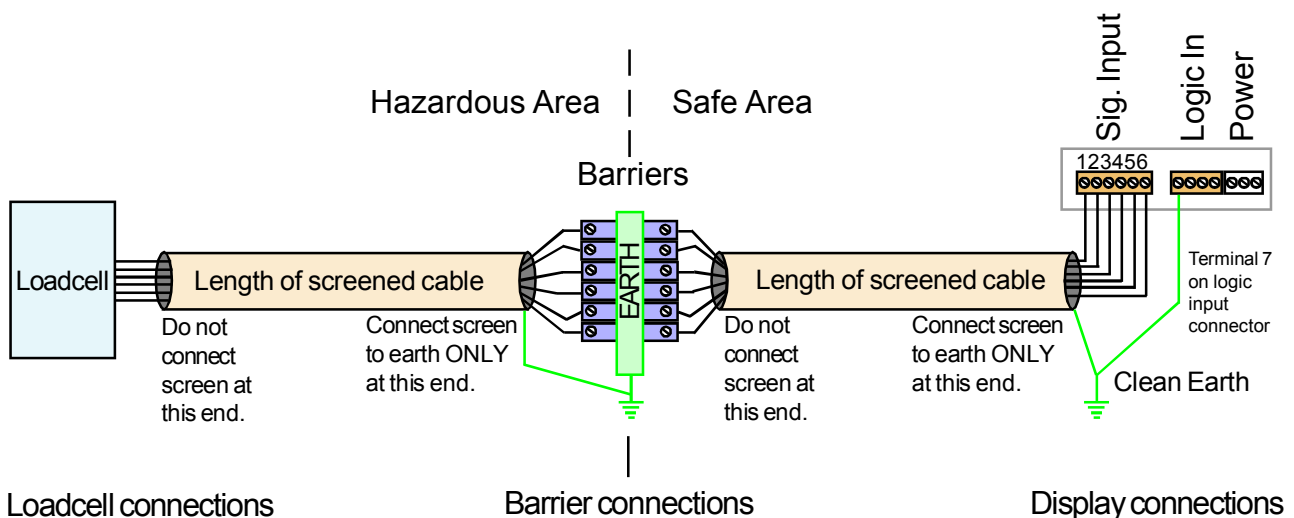

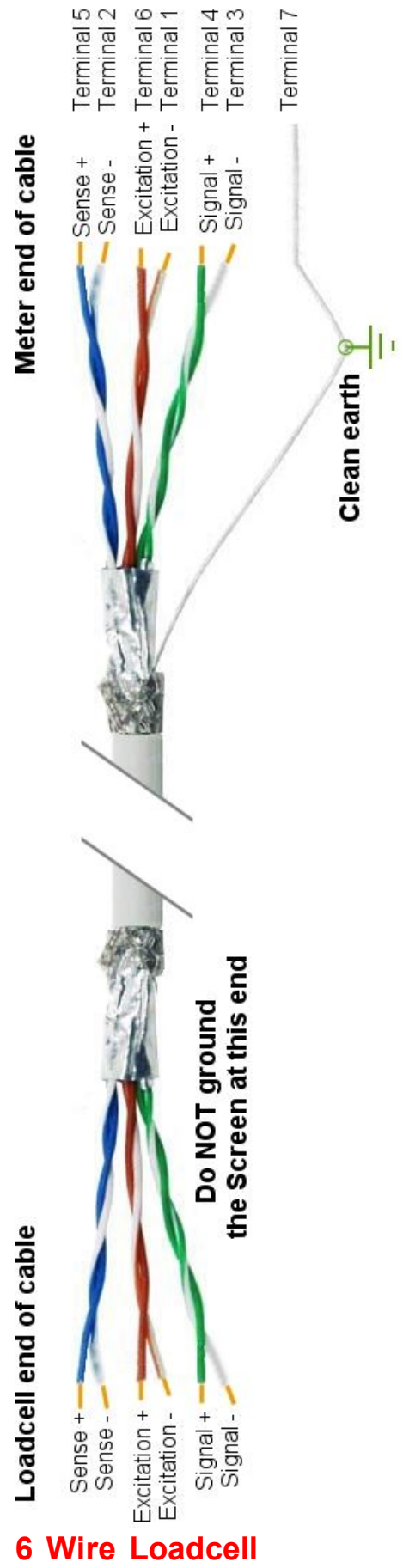
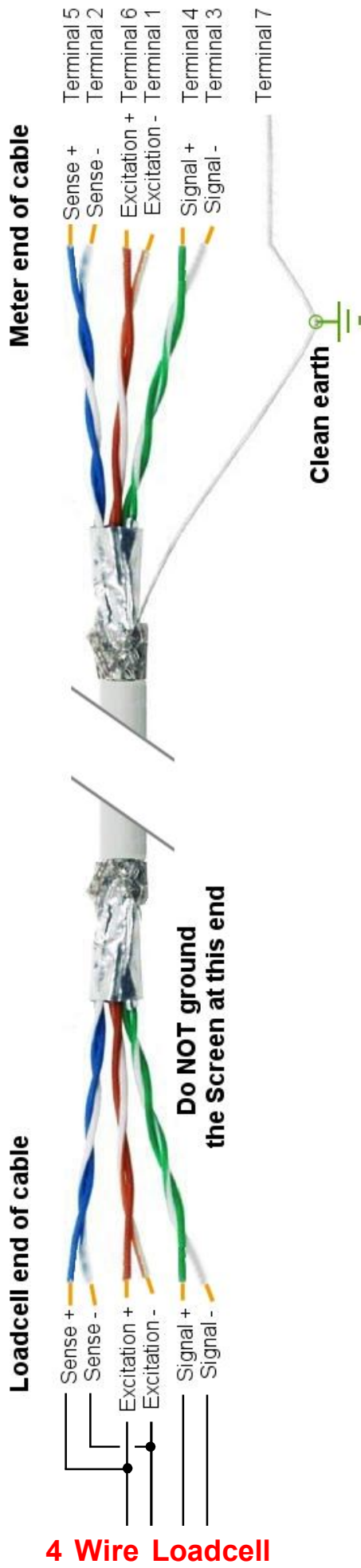

Easy or Advanced menu mode

You can choose from two menu modes.

1. Easy Mode - This limits the menu to the most commonly required features, in order to make it less complex and easier to navigate. This is the default level.

2. Advanced Mode - This gives you access to all available menu features.



Each menu feature in this manual has a heading note to tell you whether it is available in Easy or Advanced mode.

How to choose menu mode:-

This feature is available in Easy and Advanced Modes

- Lockout Switch must be OFF
Circuit board ON

Press together briefly
- Press OK a few times, until you see **Adv.** or **EASY**

Press briefly
- Each press of the DOWN arrow, or UP arrow will alternate between showing **Adv.** or **EASY**

Press to toggle
- Press OK to select your choice.

Press to accept Done!

Language Selection for user interface

You can select English or French menu prompts.

This feature is available in Easy and Advanced Modes

1

Set1 Digit Set2 Max/Min Output Alarms Lockout Switch must be OFF OFF

Press together, briefly

Circuit board ON

2

Set1 Digit Set2 Max/Min Output Alarms OK

Press to toggle

Display shows

UI Eng (Default)
for User Interface English
or
UI Fr-FR
for User Interface French

3

Set1 Digit Set2 Max/Min Output Reset Alarms OK

Press to accept

Done!

Display Brightness

You can adjust the display brightness at any time, provided the display is locked.

This feature is available in Easy and Advanced Modes

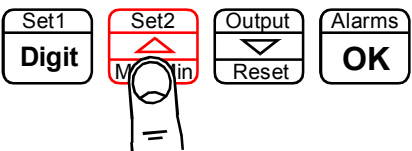
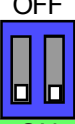
1 —  **Lockout Switch must be ON** 
Press 3 seconds Circuit board ON

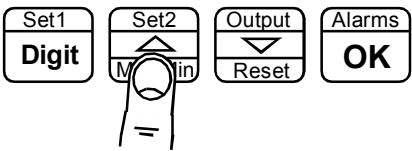
2 —  **Display shows *br ight***
Press for 3 seconds Each press of the UP button will select a new brightness level. There are 7 brightness levels to choose from. (Default = Full brightness)

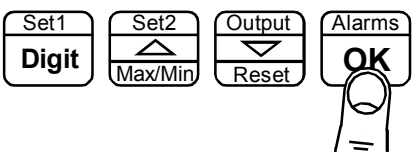
3 —  **Done!**
Press to accept



Did you know, we make this display in two brightness versions? Standard brightness for use inside, and Daylight Viewing for use outside in direct sunlight. The Daylight Viewing version has suffix -DLV in its part number.

Meter Calibration Modes

You can choose from two main calibration methods.

1. Direct Calibration - this is when you connect the meter to your system and make the meter read what you want it to, at 2 different points. *This is the preferred calibration method, because it allows you to calibrate the system as a whole.*

2. Theoretical Calibration - this is when you type in the sensor's theoretical signal level at the bottom and top of its range and then type in the value the display should show, for each signal level.

How to choose a calibration method:-

This feature is available in Easy and Advanced Modes

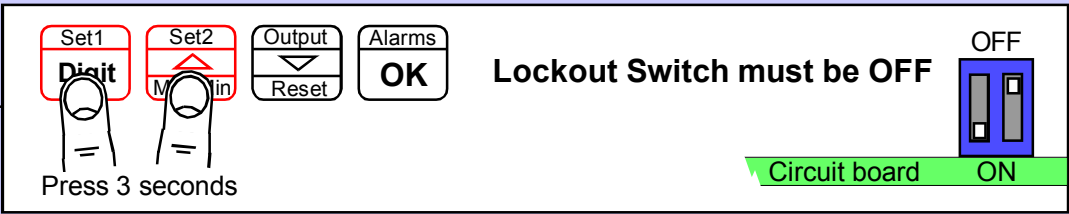
1 —  **Lockout Switch must be OFF**

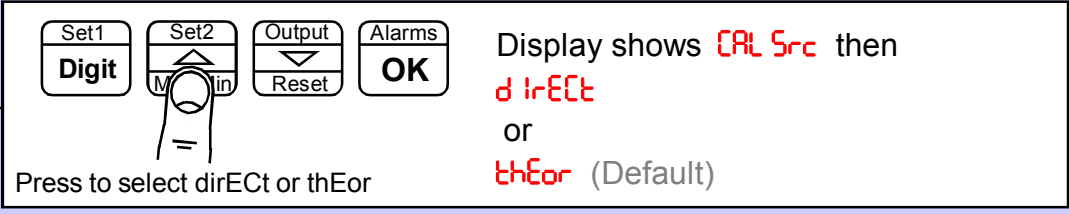
2 —  **Display shows CAL Src then dirECT or thEor (Default)**

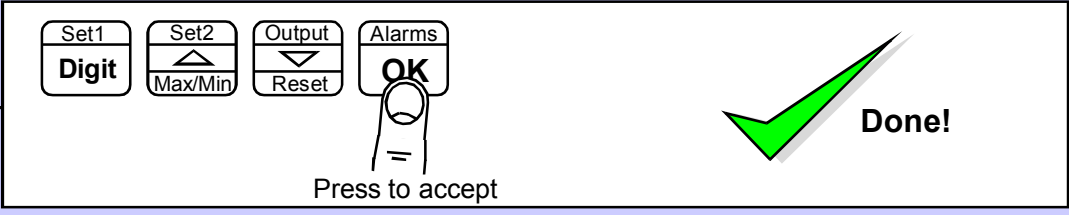
3 —  **Done!**

Direct Calibration - Full Scale Setting

This is when you connect the meter to your system and make the meter read what you want it to, at 2 different points. *This is the preferred calibration method, because it allows you to calibrate the system as a whole.*

How to do direct calibration:-

If you have not done so before, please select Direct Calibration mode from the previous page.

First we recommend you set the **FULL SCALE** calibration ...

This feature is available in Easy and Advanced Modes

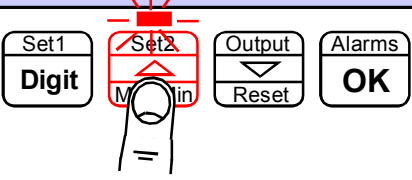
- 

1 — Press 3 seconds

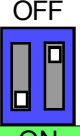
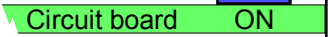
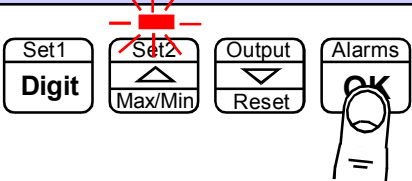
Lockout Switch must be OFF 
Display shows **d r E C t** followed by **Set H ,** 
- 

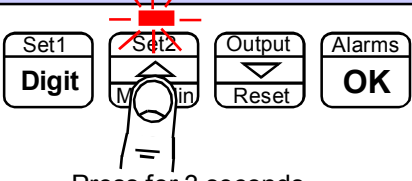
2 — Apply the highest calibration signal you can achieve, ideally 100% of system capacity. You can use less, but you will get better accuracy with higher signals. Then press OK.
- 

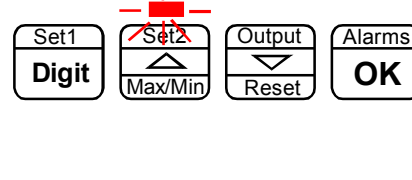
3 — Press Set2 for 3 seconds. You can now set your decimal point position using the UP or DOWN buttons. Press OK when done.
- 

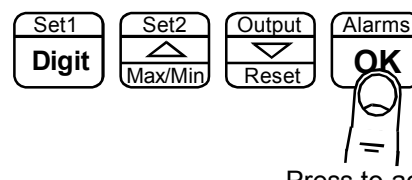
4 — You can now set the display value you want to see - use DIGIT to select each digit in turn, and the UP or DOWN arrow to increase or decrease each digit's value, as required.
- 

5 — Press to accept  **Done!**

Direct Calibration - Zero Setting

How to calibrate the **ZERO** point.

This feature is available in Easy and Advanced Modes

- 1**

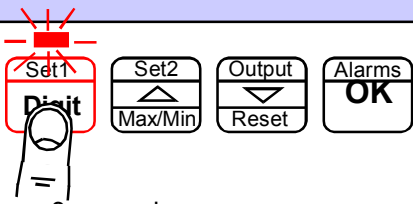

Press 3 seconds

Lockout Switch must be OFF

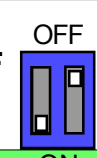

Circuit board ON
- 2**

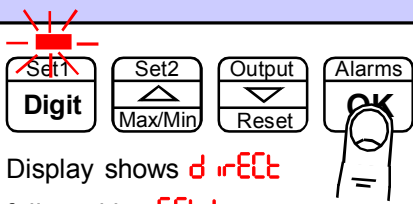

Display shows **d r E C t**
followed by **S E t L o**

Apply the lowest calibration signal you can achieve, ideally 0% of system capacity. Then Press OK.
- 3**

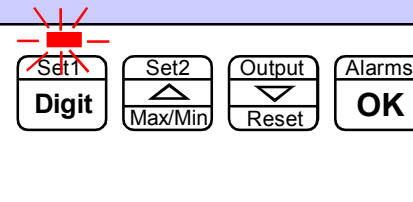

You can now set the display value you want to see - use DIGIT to select each digit in turn, and the UP or DOWN arrow to increase or decrease each digit's value, as required.
- 4**

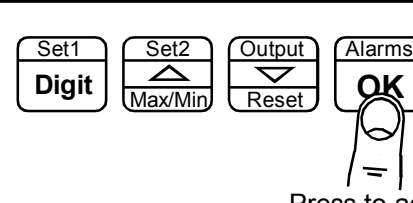

Press to accept

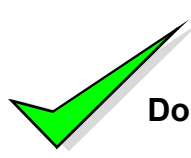

Done!

You can set Zero first, if you prefer, but you will not be able to change the decimal point position in the ZERO calibration step.

This will not be an issue if your zero calibration reading is 0, but may become confusing otherwise.

When you have finished your calibration, please remember to put the calibration lockout switch in its ON position, to protect your settings.

Linearisation with Direct Calibration

If your system is non linear, you can calibrate the meter and correct for this with the lineariser function.

You will need to apply a series of known loads, starting at 0 and working up to full scale. You will then tell the meter what it should read for each applied load. You can use up to 10 points.

First, you must select Direct Calibration Mode (see page on calibration Modes)
Then, proceed as shown below...

This feature is available in Easy and Advanced Modes

- 1

Set1
Digit

Set2
Max/Min

Output
Reset

Alarms
OK

Lockout Switch must be OFF

Display will show L in.0n or L in.OFF (Default)

OFF

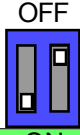

ON

Press together, briefly
- 2

Set1
Digit

Set2
Max/Min

Output
Reset

Alarms
OK

If the display shows L in.OFF, press Set2 button briefly so that the display shows L in.0n, then press OK
- 3

Set1
Digit

Set2
Max/Min

Output
Reset

Alarms
OK

The display will show SEt 00

Ensure no load is applied to the system and press OK.

The display will now show rd 00

You can now tell the meter what it should display for this load.

Select each digit in turn with the DIGIT button, and increase or decrease each digit's value using the UP or DOWN button, until the display is set as required. Press OK when done.
- 4

Set1
Digit

Set2
Max/Min

Output
Reset

Alarms
OK

The display will show Add.Pt

Press OK

Continued ...

Linearisation with Direct Calibration - cont'd.

5

Set1
Digit

Set2
Max/Min

Output
Reset

Alarms
OK

The display will show **Set 0!**
Apply your 1st known load to the system and press OK.

The display will now show **rd 0!**
You can now tell the meter what it should display for this load.

Select each digit in turn with the DIGIT button, and increase or decrease each digit's value using the UP or DOWN button, until the display is set as required. Press OK when done.

6

Set1
Digit

Set2
Max/Min

Output
Reset

Alarms
OK

The display will show **Add Pt**

Press OK if you want to Add another calibration point, you will repeat the previous steps, each time incrementing "Set XX" and "rd XX" up to Set 09 and rd 09 which are the last available points.

If you want to finish adding points, press Set2 until the display shows **SAVE**, and then confirm by pressing OK

If you want to abort the setup, press Set2 until the display shows **Quit** and then press OK

7

Set1
Digit

Set2
Max/Min

Output
Reset

Alarms
OK

Done!

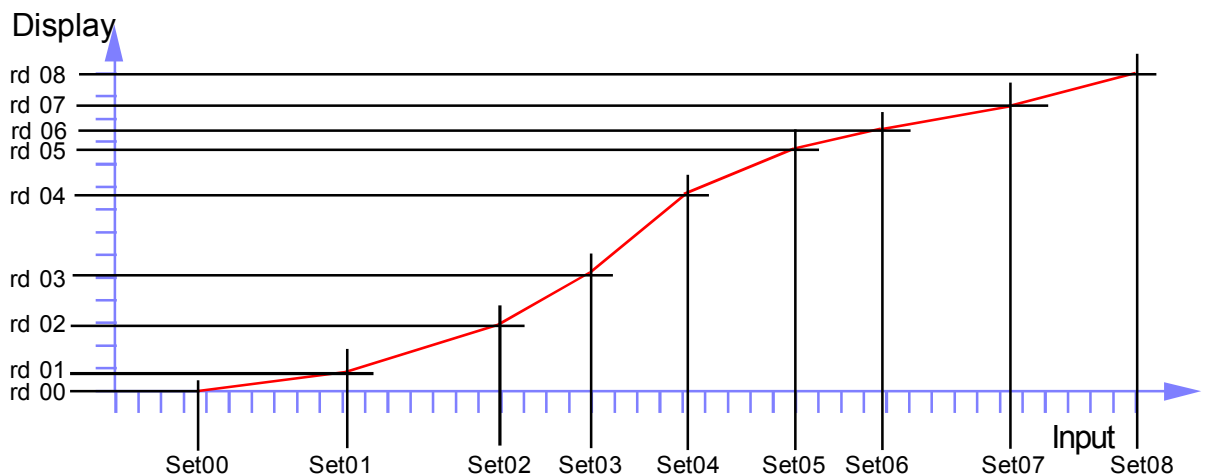

Theoretical Cal. - Decimal Point & Full Scale

This is when you type in the sensor's theoretical signal level at the top and bottom of its range and the value to display, for each signal level.



If you have not done so before, please select Theoretical Calibration mode from the **Meter Calibration** page AND choose whether your input is current or voltage.

First we recommend you set the **FULL SCALE** calibration ...

This feature is available in Easy and Advanced Modes

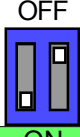
- 1** Lockout Switch must be OFF  Circuit board ON

Press 3 seconds
- 2** Display shows **thEor**
- 3** You can now specify the maximum input signal. Use DIGIT to select each digit in turn, and the UP or DOWN arrow to increase or decrease each digit's value, as required. eg set **20.0000** if your high input is 20mV

Press to accept
- 4** Display now shows **rdH**, briefly. You can now specify the maximum reading and decimal point position. Press Set2 button for 3 seconds to set decimal point position. Use up and down arrows to move the decimal point and press OK when done. Then, use DIGIT to select each digit in turn, and the UP or DOWN arrow to increase or decrease each digit's value, as required. Set **100.000** if your display range is 0 to 100.000

Default scaling is
0-40mv = 0-40.000
- 5** Done!

Press to accept

Theoretical Calibration - Low end calibration

This is when you type in the sensor's theoretical signal level at the top and bottom of its range and the value to display, for each signal level.

If you have not done so before, please select Theoretical Calibration mode from the **Meter Calibration** page.

This feature is available in Easy and Advanced Modes

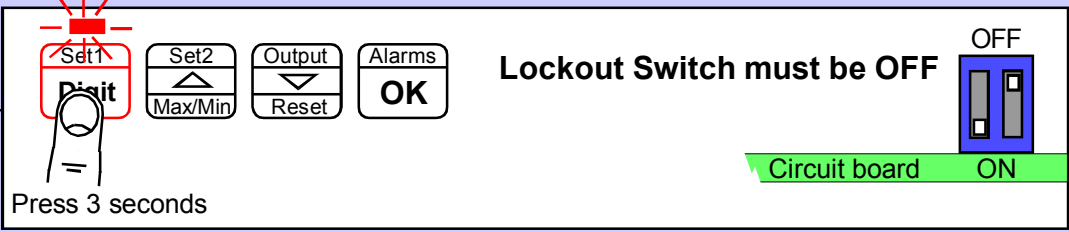
- 

Press 3 seconds

Lockout Switch must be OFF

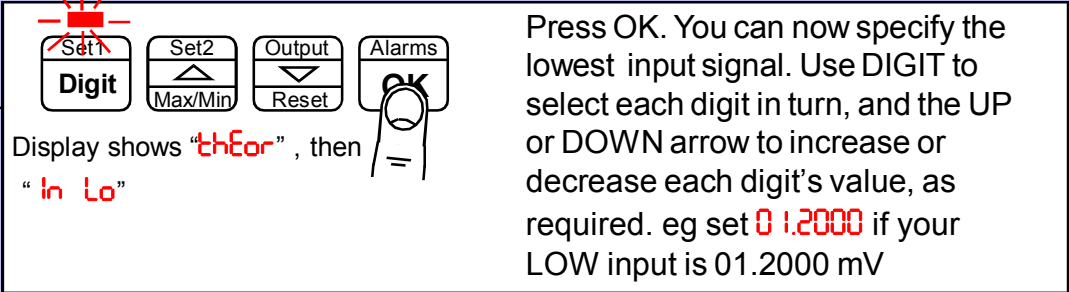
Circuit board ON
- 

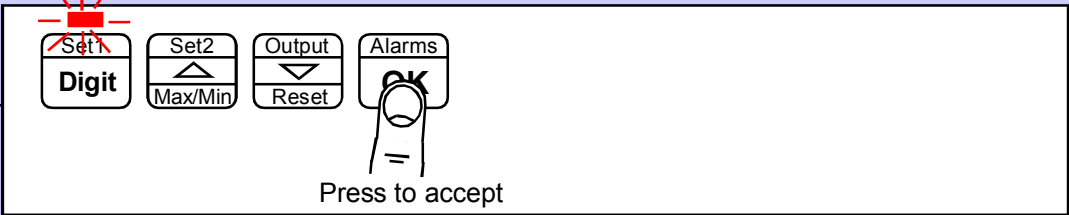
Press OK. You can now specify the lowest input signal. Use DIGIT to select each digit in turn, and the UP or DOWN arrow to increase or decrease each digit's value, as required. eg set 01.2000 if your LOW input is 01.2000 mV
- 

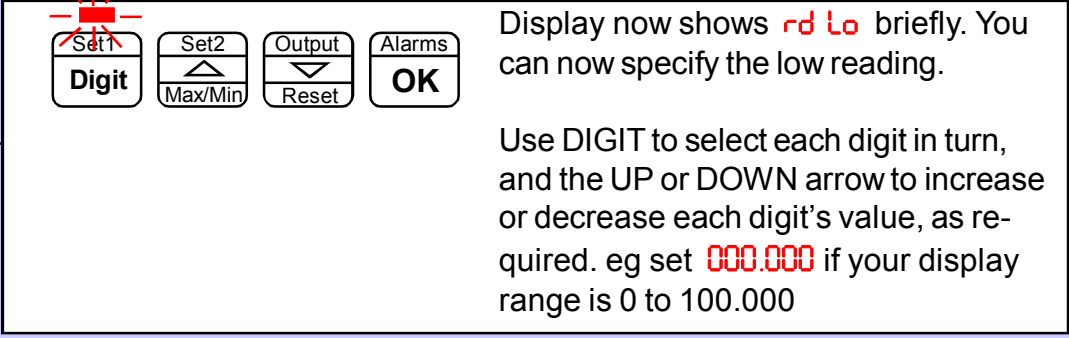
Press to accept
- 

Display now shows rd Lo briefly. You can now specify the low reading.

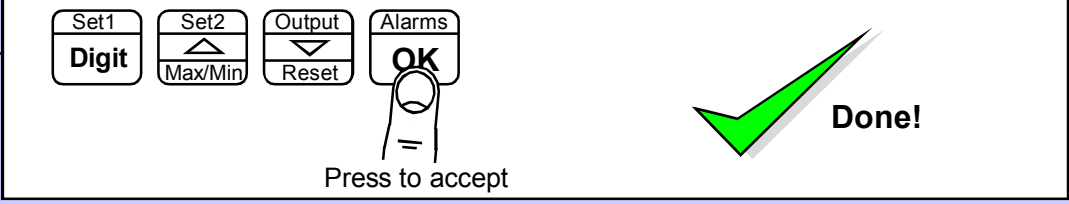
Use DIGIT to select each digit in turn, and the UP or DOWN arrow to increase or decrease each digit's value, as required. eg set 000.000 if your display range is 0 to 100.000
- 

Press to accept

Done!

You can set Zero first, if you prefer, but you will not be able to change the decimal point position in the ZERO calibration step. This will not be an issue if your zero calibration reading is 0, but may become confusing otherwise.

Linearisation with Theoretical Cal.

If your system is non linear, you can calibrate the meter and correct for this with the lineariser function.

With this method, you can enter theoretical values for input signal and display values, without having to connect a sensor.

First, you must select Theoretical Calibration Mode (see page on calibration Modes) Then, proceed as shown below...

This feature is available in Easy and Advanced Modes

- 1

Set1
Digit

Set2
↑
↓
lin

Output
↓
Reset

Alarms
OK

Lockout Switch must be OFF

Display will show
L in.0n or L in.OFF

OFF

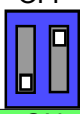

Circuit board ON

Press together, briefly
- 2

Set1
Digit

Set2
↑
↓
lin

Output
↓
Reset

Alarms
OK

If the display shows L in.OFF, press Set2 button briefly so that the display shows L in.0n, then press OK
- 3

Set1
Digit

Set2
△
▽
Max/Min

Output
↓
Reset

Alarms
OK

The display will show in 00 followed by an editing screen. Here you can enter your first calibration input signal level using DIGIT button to select each digit in turn. Increase or decrease the value of each digit using the UP or DOWN buttons. Press OK when set.

The display will now show rd 00
You can now tell the meter what it should display for this input signal.

Select each digit in turn with the DIGIT button, and increase or decrease each digit's value using the UP or DOWN button, until the display is set as required. Press OK when done.
- 4

Set1
Digit

Set2
△
▽
Max/Min

Output
↓
Reset

Alarms
OK

Display will show Add.Pt

Press OK

Continued ...

Linearisation with Theoretical Cal. - cont'd.

5

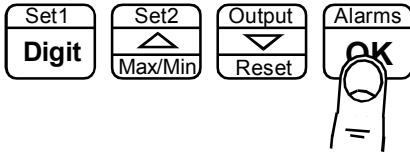
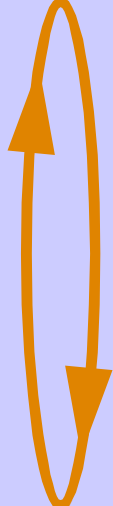

The display will show **In 0 1** followed by an editing screen. Here you can enter your next calibration input signal level using DIGIT button to select each digit in turn. Increase or decrease the value of each digit using the UP or DOWN buttons. Press OK when set.

The display will now show **rd 0 1**. You can now tell the meter what it should display for this input signal.

Select each digit in turn with the DIGIT button, and increase or decrease each digit's value using the UP or DOWN button, until the display is set as required. Press OK when done.

6

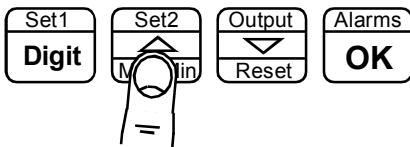

The display will show **Add.Pt**

Press OK if you want to Add another calibration point, you will repeat the previous steps, each time incrementing **In XX** and **rd XX** up to In 09 and rd 09 which are the last available points.

If you want to finish adding points, press Set2 until the display shows **SAVE**, and then confirm by pressing OK

If you want to abort the setup, press Set2 until the display shows **Quit** and then press OK

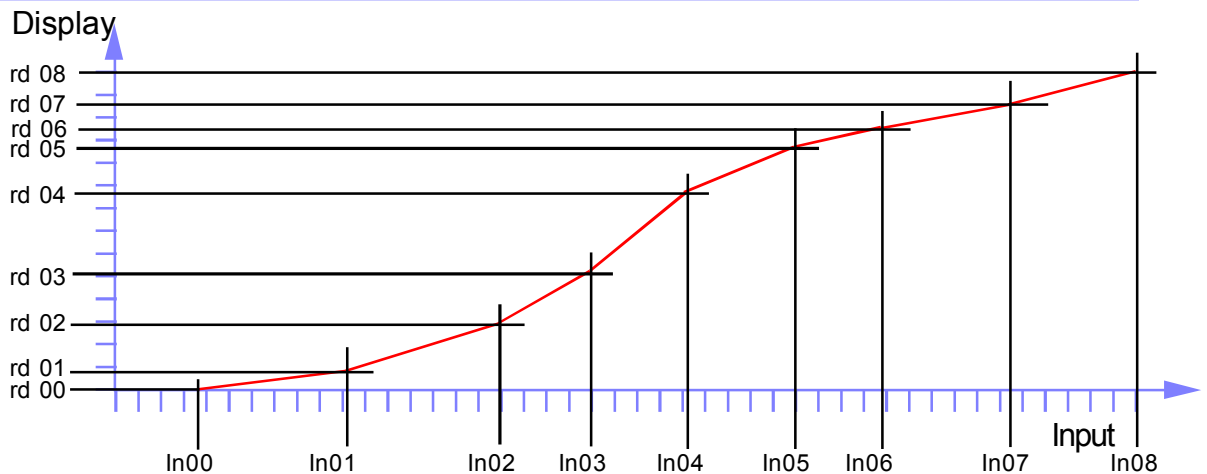

Sensor Drift correction

If your system is normally reading 0, for example as is typical with platform scales or a torque meter, you may find a small amount of sensor drift caused by changes in temperature, ageing etc.

We can automatically correct for slow, long term drift, by comparing your signal to 0 every 30 seconds, and re-calibrating to remove any detected movement.

This does not affect the sensitivity of your system, and is only applied for readings less than 8 least-significant counts.

The corrected value is stored in non-volatile memory, so that any drift trend will be re-applied after you have switched off the meter.

This feature is available in Easy and Advanced Modes

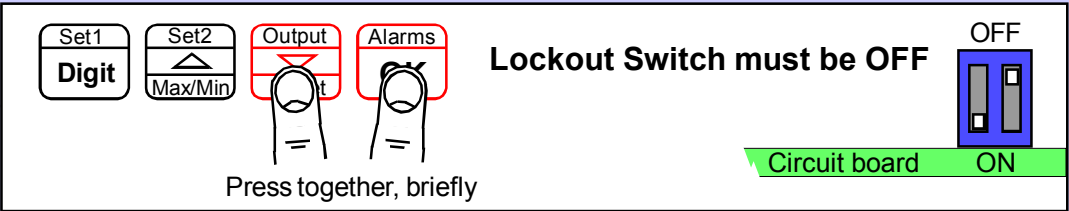
- 

1 Press together, briefly

Lockout Switch must be OFF

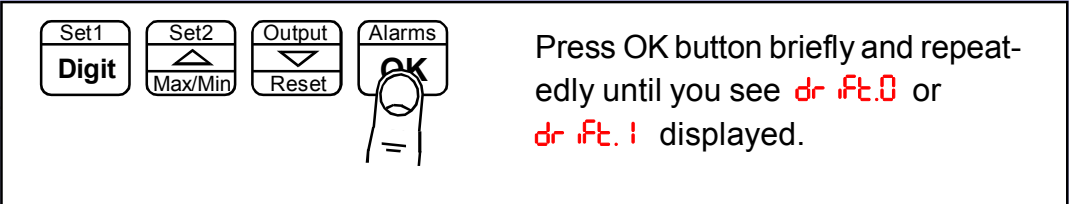
Circuit board ON
- 

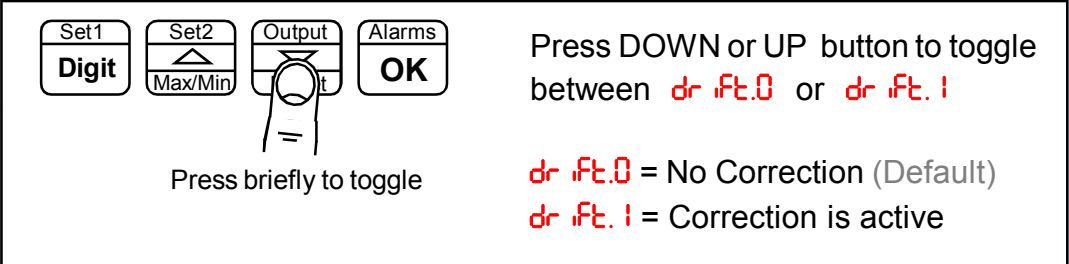
2 Press OK button briefly and repeatedly until you see **drift.0** or **drift.!** displayed.
- 

3 Press DOWN or UP button to toggle between **drift.0** or **drift.!**

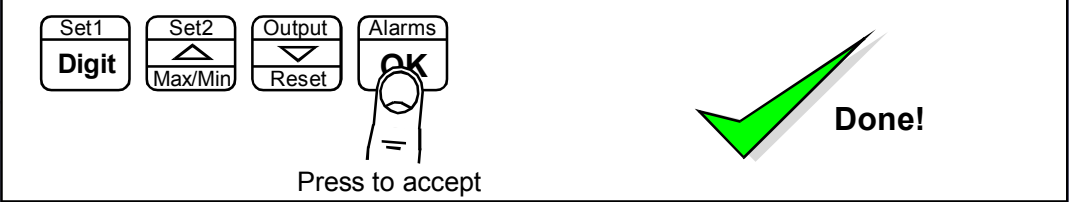
drift.0 = No Correction (Default)
drift.! = Correction is active
- 

4 Press to accept

Done!

Logic input functions

The three contact closure inputs on the rear of the meter have default functions which are:-

- Contact closure 1 = Tare
- Contact closure 2 = Peak/Valley display
- Contact closure 3 = Reset

You can re-assign these to include :HOLD, Nett/Gross value display, Memory page address 1,2 or 4 (only if Multi-memory MEM option is installed)

!! This feature is available in Advanced Mode only !!

1

Set1
Digit

Set2
Max/Min

Output
↓
Reset

Alarms
OK

Lockout Switch must be OFF

OFF

Press 3 seconds

Circuit board

ON

2

Set1
Digit

Set2
Max/Min

Output
↓
Reset

Alarms
OK

Press repeatedly until you see **CC.1**, followed by the existing function for Contact Closure 1.

After you have set **CC.1**, you will get the prompt **CC.2** to allow you to set Contact Closure 2 function and when you have set CC.2 you will get the prompt **CC.3** to allow you to set Contact Closure 3 function

3

Set1
Digit

Set2
Max/Min

Output
↓
Reset

Alarms
OK

Use UP or DOWN buttons to select from these available functions...

<p>Defaults are:-</p> <p>CC.1 = TARE</p> <p>CC.2 = PU</p> <p>CC.3 = rSt</p>	<p>TARE = Tare display to 0</p> <p>PU = Peak/Valley toggle</p> <p>rSt = Reset</p> <p>HoLd = Freeze display</p> <p>neT.Gro = Nett / Gross display</p> <p>PA.1 = Page Address 1*</p> <p>PA.2 = Page Address 2*</p> <p>PA.4 = Page Address 4*</p>
--	--

4

Set1
Digit

Set2
Max/Min

Output
↓
Reset

Alarms
OK

Press to accept

Done!

* Only available if the Multi-memory MEM option is installed

27

Logic input connections and front buttons

The previous page explained how to select the functions of the 3 logic inputs. You can connect remote contact closures or open NPN collectors to activate these logic inputs.

The logic input provides a 5V DC signal. When you connect this to common, a current of 1mA will flow. Because this is a small signal, we recommend you use switches with gold plated contacts, or self cleaning contacts, for best long term reliability.

The logic inputs are not galvanically isolated from the input signal.

The logic inputs are only activated when the lockout switch is ON

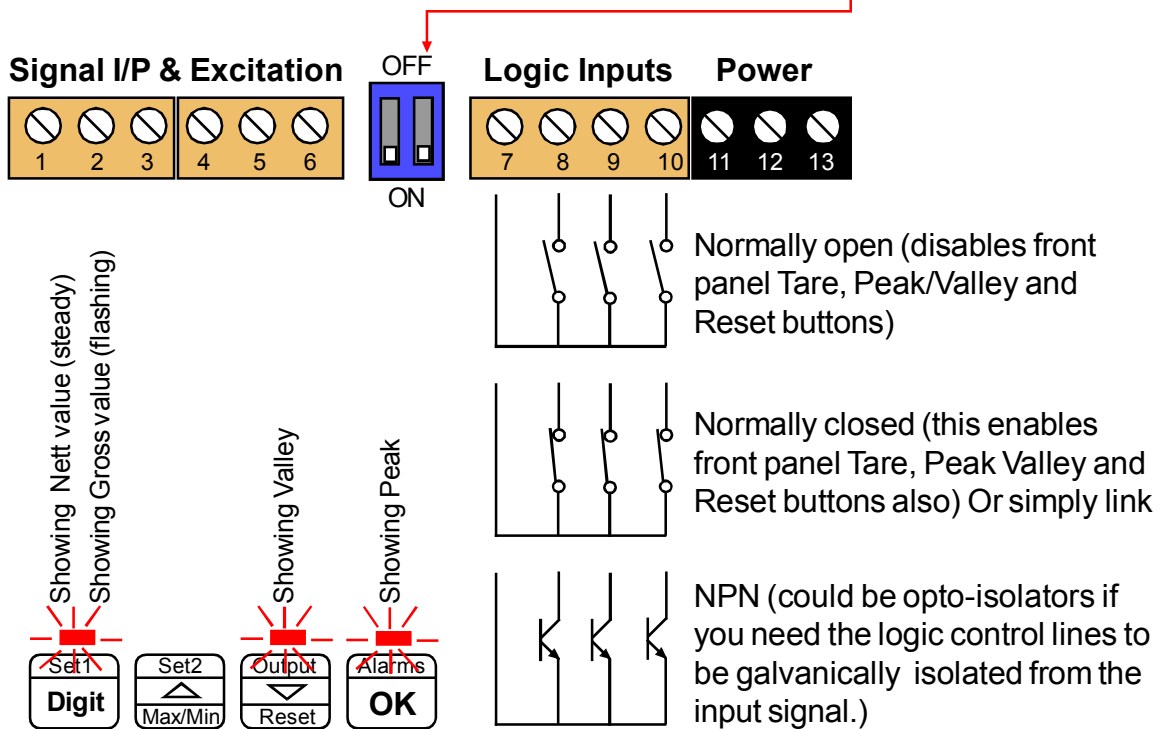

TARE = Tares display to 0. Often used in weighing systems to zero a display prior to making a measurement. Net weight is shown once tared. When a display has been tared the small LED above the Set1 button will be illuminated.

PU = Peak/Valley toggle. Allows you to view the maximum and minimum values which have been displayed since last reset. 0% LED illuminates when showing valley, 100% LED illuminates when showing peak.

rst = Reset. This clears any tare, peak, valley, alarm latch

Hold = Freezes the displayed value for as long as the Hold input is closed

net.gro = Allows you to toggle between Nett and Gross values on the display

PA.1 .. 4 = Page Addresses, if MEM option is installed.

Factory Defaults

You can return the display to its factory default conditions whenever you wish. If you do so, you will permanently lose all your settings and will need to start from the beginning again.

The calibration Audit Counter will NOT be reset, there is no way provided to reset this value, as it is intended as a secure record to indicate whether changes have been made to the display since it was last calibrated..

This feature is available in Easy and Advanced Modes

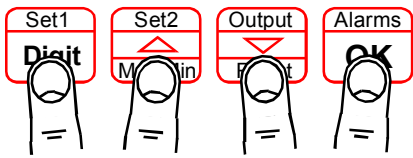
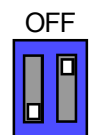
1 —  **Lockout Switch must be OFF** 
Press together for 3 seconds Circuit board ON

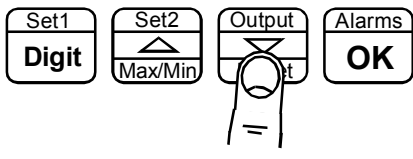

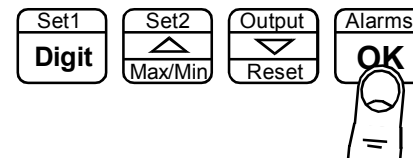
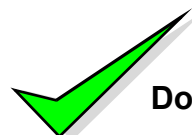
2 —  Display shows :- **dEFS n** (Defaults no)
Press the DOWN button to change the display to **dEFS Y** (Defaults Yes) if you want to return to default conditions.

3 —   **Done!**
Press to accept

Calibration audit number

Your display includes a non-resettable counter which increments each time you make a change to the display's calibration. This is useful if you want to check whether a display has been altered since it was last calibrated.

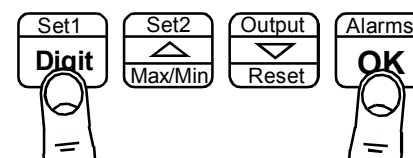
The Calibration audit number starts at **CAL 01** up to **CAL FF** allowing up to 255 alterations to be recorded. Whenever you want to check the calibration audit number, press and hold the 2 outer buttons (Set1 + Alarms) for more than 3 seconds.

1 —   **Done!**
Press together for 3 seconds

Signal Filtering / Averaging

You can adjust the filtering time constant to reduce the effect of noise or instability on your input signal.

A larger FIL value will give a more stable display, but the response to signal changes will be slower.

Because your output options, such as analogue output, alarm relays and serial output are all derived from the displayed value, they will respond at the same rate as the filtered display.

This feature is available in Easy and Advanced Modes

- 1

Set1
Digit

Set2
Max/Min

Output
Reset

Alarms
OK

Lockout Switch must be OFF

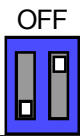



Press 3 seconds

Circuit board ON
- 2

Set1
Digit

Set2
Max/Min

Output
Reset

Alarms
OK



Select, then press OK to accept

Display shows **HF I.X** where **X** is the amount of basic filtering.
A=Low **b**=Medium **C**=High **d**=Most
 (Default = **HF I.C**)
- 3

Set1
Digit

Set2
Max/Min

Output
Reset

Alarms
OK



Select, then press OK to accept

Display shows **F IL.XX.X** where **XX.X** is the time constant in seconds.
 Use the UP or DOWN button to increase or decrease this value
 (Default = **F IL.00.0**)
- 4

Set1
Digit

Set2
Max/Min

Output
Reset

Alarms
OK



Press to accept



Done!

See also Filter Jump setting in the Advanced Menu, if your signal is particularly noisy and you cannot get sufficient smoothing with this filter.

Filter Jump value

See the Easy/Advanced mode selection page near the beginning of this manual, and choose advanced mode.

The Filter Jump value allows you to decide how the display will respond to a process step change. It does this by overriding the filtering, if the input signal moves by more than a chosen amount in one conversion. The Filter Jump default value is 10%.

This means that for noise amplitude which has a peak value of less than 10% of the input range, filtering will be applied. Any signal movement greater than 10% of the input range will cause the display to jump immediately to that value, without filtering. After that jump, normal filtering will be re-applied, provided signal movement thereafter is less than 10% per conversion.

Guidance:

For noisy systems, increase the Filter Jump value up to a maximum of 99. Choose a value which gives a good compromise between filtering and response speed.

For reasonably clean signals, a Filter Jump value of around 10 or less will give a good compromise between filtering and response speed to step change inputs.

!! This feature is available in Advanced Mode only !!

1

Set1	Set2	Output	Alarms
Digit	▲ Min	▼ Set	OK

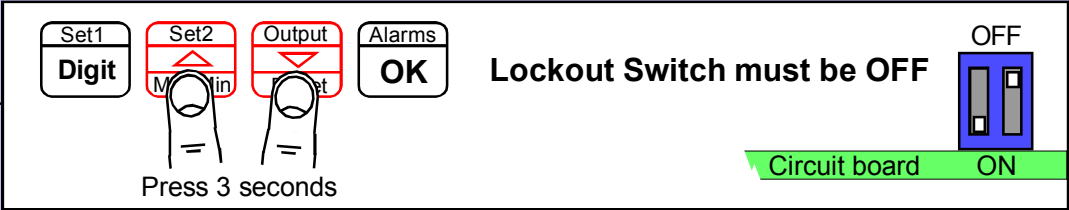
Press 3 seconds

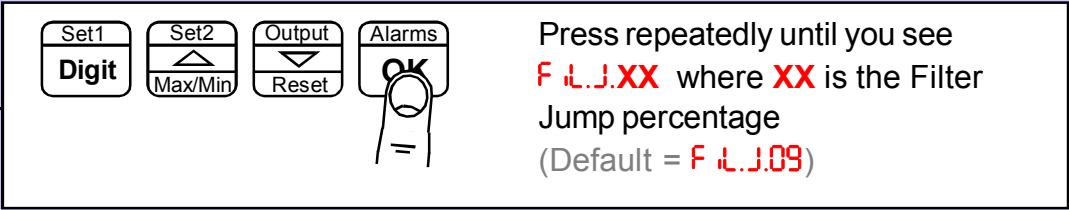
Press 3 seconds

Alarms
OK

Lockout Switch must be OFF

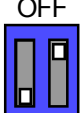
OFF

ON

Circuit board ON

2

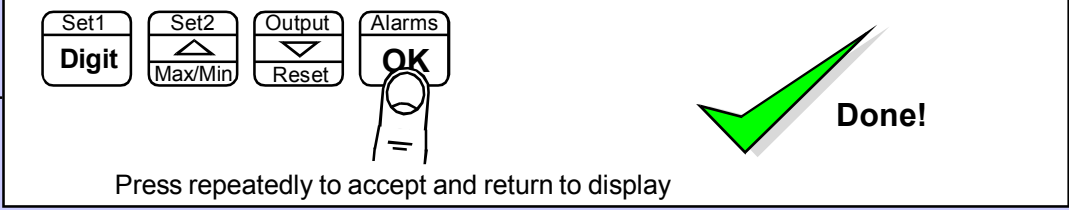
Set1	Set2	Output	Alarms
Digit	▲ Max/Min	▼ Reset	OK



Press repeatedly until you see **F L.J.XX** where **XX** is the Filter Jump percentage
(Default = **F L.J.09**)

3

Set1	Set2	Output	Alarms
Digit	▲ Max/Min	▼ Reset	OK

Alarms
OK

You can set from **00** to **99**. Use the DIGIT and UP or DOWN button to increase or decrease this value.

4

Set1	Set2	Output	Alarms
Digit	▲ Max/Min	▼ Reset	OK

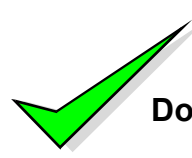

Alarms
OK

Done!

Press repeatedly to accept and return to display

Last Digit rounding up by 1, 2, 5, 10, 20 or 50

You can adjust the way the display rounds up, which is useful if you want to display a very large number, but do not want jitter on the last digit.

The display can be set to round up to the nearest 1 (no rounding) 2, 5, 10, 20 or 50

This feature is available in Easy and Advanced Modes

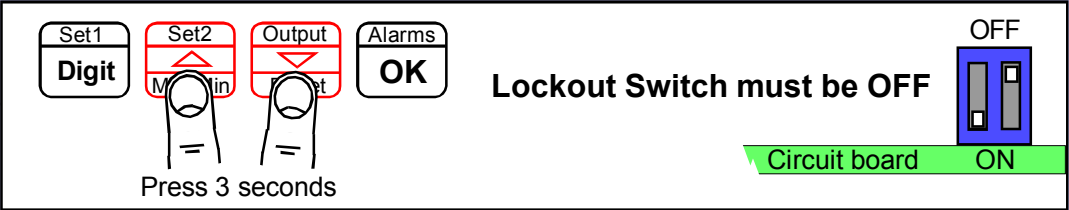
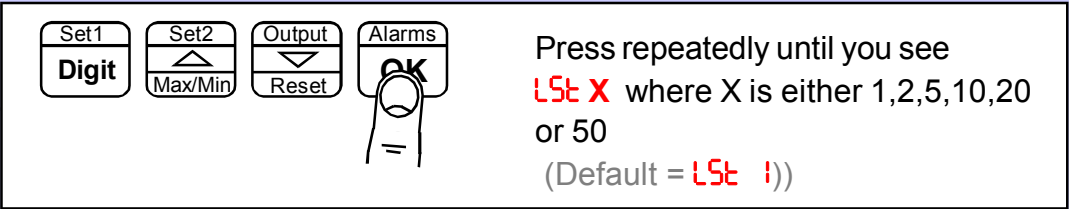
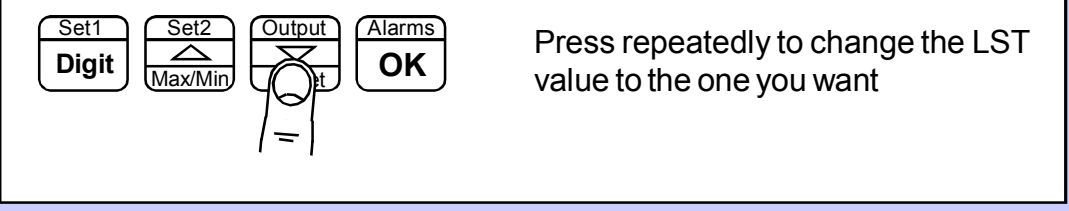
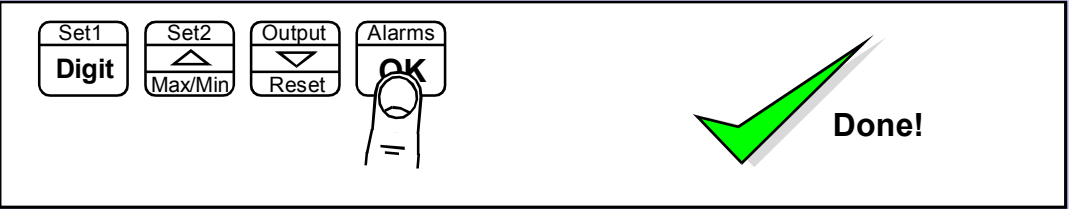
- 1** — 
- 2** — 
- 3** — 
- 4** — 

Scale Factor adjustment

After you have calibrated your meter, you can use the SCALE feature to make fine adjustments to calibration, without affecting the calibration itself.

Examples

1. Changing weight units of measure from kg to pounds

You could also use the SCALE to convert your readout from kg to pounds, without affecting the calibration. Simply set SCALE = 2.205 and your meter which was calibrated in kg will now read in pounds.

2. Correcting for gravitational variance

Your weighing system was calibrated where gravitational acceleration = 9.812m/s^2 (London) You then move the system to Bangkok where gravitational acceleration is reduced to 9.782m/s^2

You can correct for this difference by setting Scale = $9.812 / 9.782 = 1.003$, so that a given mass in Bangkok will show the same weight as it did in London. Set Offset = 0.0000

See http://en.wikipedia.org/wiki/Earth%27s_gravity

!! This feature is available in Advanced Mode only !!

- Press 3 seconds

Lockout Switch must be OFF

Circuit board

OFF
ON
- Press repeatedly until you see **SCALE**, followed by the existing scale factor. (Default = **00 1.000**)
- Use DIGIT button to select each digit in turn, UP or DOWN buttons to increase or decrease each digit's value. Press OK when done.
- Press to accept

Done!

You may want to adjust an offset value also, see separate OFFSET page for this feature.

Offset adjustment

After you have calibrated your meter, you can use the **OFFSET** feature to make fine additions or subtractions to the reading, without affecting the calibration itself.

For example if your weighing structure is altered after calibration and you want to subtract the effect of 37kg of extra metalwork which was welded to the hopper, you can easily do this by entering a value of -37 in the offset value.

!! This feature is available in Advanced Mode only !!

1

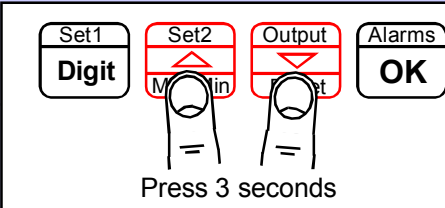

Press 3 seconds

Lockout Switch must be OFF

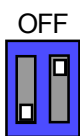

Circuit board **ON**

2

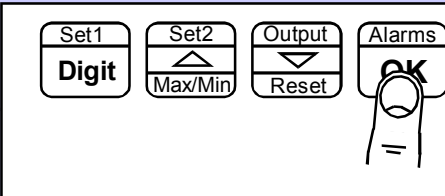

Press repeatedly until you see **OFFSEt**, followed by the existing offset value. (Default is **000.000**)

3

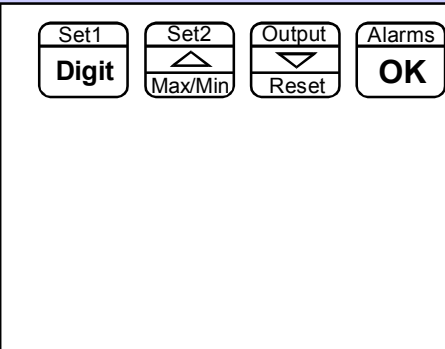

Use **DIGIT** button to select each digit in turn, **UP** or **DOWN** buttons to increase or decrease each digit's value. If you want to set a negative value, use **DIGIT** to select the left hand digit, and press the down button to go below 0 to activate the - sign. Press **OK** when done.

4

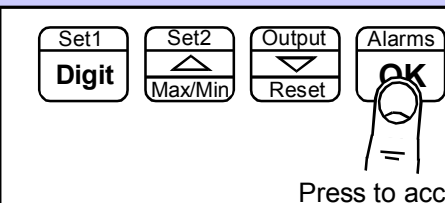

Press to accept



Done!

You may want to adjust a **SCALE FACTOR** value also, without affecting calibration. See the separate **SCALE** page for this feature.

Menu timeout adjustment

The display has a default timeout of 60 seconds, to allow you sufficient time to refer to the manual between key operations.

You can make this period shorter, if you wish, once you become more familiar with the setup method.

!! This feature is available in Advanced Mode only !!

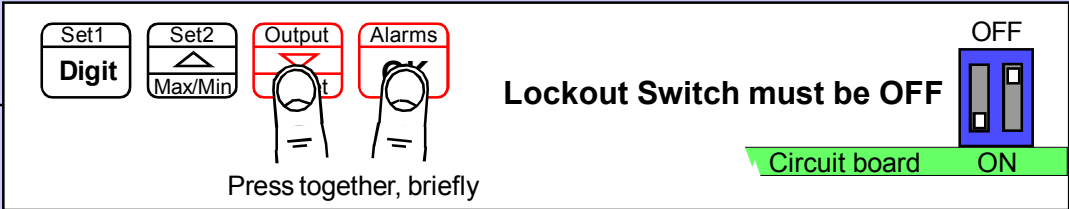
1 —  Lockout Switch must be OFF
Circuit board ON

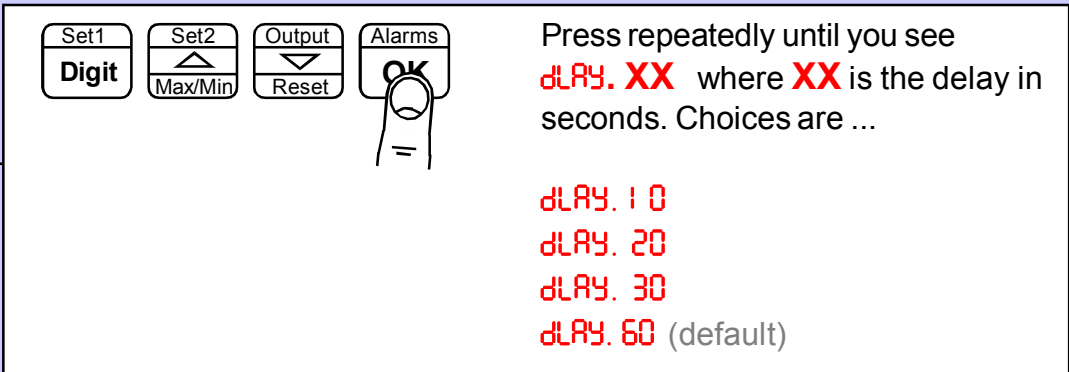
2 —  Press repeatedly until you see **dLAY. XX** where **XX** is the delay in seconds. Choices are ...
dLAY. 10
dLAY. 20
dLAY. 30
dLAY. 60 (default)

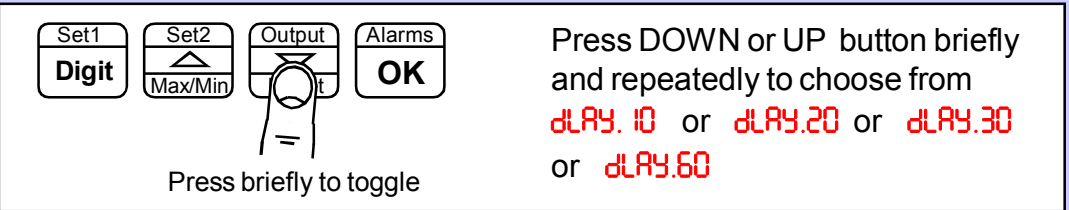
3 —  Press DOWN or UP button briefly and repeatedly to choose from **dLAY. 10** or **dLAY.20** or **dLAY.30** or **dLAY.60**

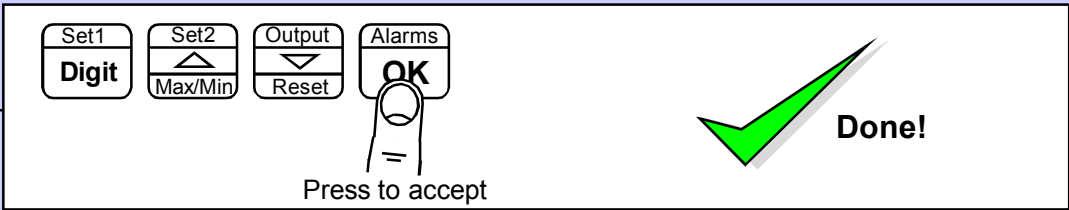
4 —  Press to accept
Done!

Reverse Display function (mirror image)

If you need to be able to see a reflection of the display in a mirror or other reflective surface, for example in a simple heads-up system, or for drivers reversing into a bay, using mirrors only, you can set the display to show as a mirror image.

!! This feature is available in Advanced Mode only !!

- Lockout Switch must be OFF

Press together, briefly
- Press OK button briefly and repeatedly until you see

rEU.d 0 (Default)
or
rEU.d 1
- Press DOWN or UP button briefly and repeatedly to choose from

rEU.d 0 (normal display) or
rEU.d 1 (mirror image display)
- Press to accept

Done!



Example of normal display format displaying the number 876543



Example of Mirror Reverse display format displaying the number 876543

Bootup routine choices

When you switch on your meter, it can be set to power up with 3 possible summary message combinations.

The choices are:-

- boot 0** = Segment test, followed by a full summary of software revision, calibration audit number, model number, installed options.
- boot 1** = Segment test followed by model number (Default)
- boot 2** = No summary, meter displays the measurement value immediately power is applied.
- boot 3** = Segment test displays permanently, until any button pressed.

!! This feature is available in Advanced Mode only !!

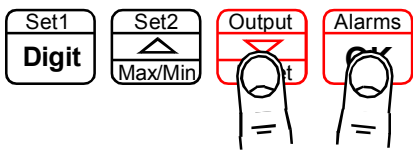
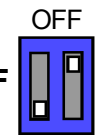
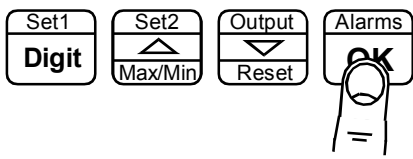
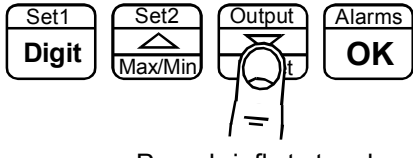
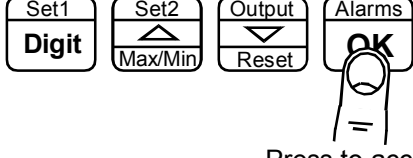
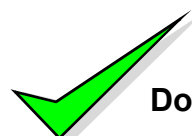
- 1**  **Lockout Switch must be OFF** 
Press together, briefly
- 2**  Press OK button briefly and repeatedly until you see **boot 0** or **boot 1** or **boot 2** displayed.
- 3**  Press DOWN or UP button briefly and repeatedly to choose from **boot 0** or **boot 1** or **boot 2**
Press briefly to toggle
- 4**   **Done!**
Press to accept



You can trigger the full summary message whenever you want, without having to power the meter off, by pressing and holding the 2 outer buttons (Set1 + Alarms) for more than 3 seconds.

Multi-Program Memory option MEM

The three contact closure inputs on the rear of the meter may be used to call up between 1 to 7 additional meter setup memories (pages), if the MEM option has been installed. This allows you to save up to 8 complete sets of independent calibrations, alarm settings, analogue output settings and serial comms settings.

First decide how many memory pages you want, as this will determine how many logic inputs you will need to use for the addressing. Logic inputs not required for Page Addressing can be used for other functions such as Tare, Reset, Display Hold, Peak/Valley display.

If you have used all 3 logic inputs for Page Addressing, you can still use the meter's front panel buttons to perform Tare, Reset and peak/Valley view.

See "Contact Closure Input Functions" page for CC.1, CC.2, CC.3 and COP settings

Total number of pages	Logic Inputs required for addressing
1	none, standard single page meter
2	1 Set CC.1 = PA.1
3 or 4	2 Set CC.1 = PA.1, Set CC.2 = PA.2
5 to 8	3 Set CC.1 = PA.1, Set CC.2 = PA.2, Set CC.3 = PA.4

1. Set lockout switches OFF, and set page address to 0 or unplug the logic connector.
2. Set the copy instruction to **COP. 1** in page address 0 (found after you set CC3) .
3. Press all 4 buttons together, display shows **dEFS. n**
4. Press the Up arrow to change display to **dEFS. y** and press OK.
5. If you want all channels to share a common setting, eg calibration, do that setting now.
6. When you want to do separate settings for each channel, set COP.0

Programming and recalling individual pages

Plug the logic input connector back in, if you removed it earlier. Select a page address using the switch combinations shown below, wired to the Logic Input connector ...

Page address 0	All logic inputs open
Page address 1	CC.1 closed to Common
Page address 2	CC.2 closed to Common
Page address 3	CC.1 and CC.2 closed to Common
Page address 4	CC.4 closed to Common
Page address 5	CC.1 and CC.3 closed to Common
Page address 6	CC.2 and CC.3 closed to Common
Page address 7	All logic inputs closed to Common

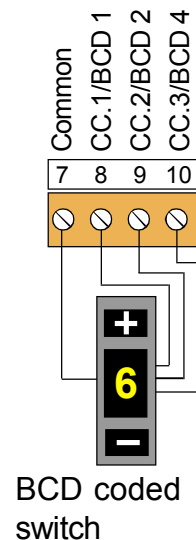

Perform the settings you require, according to the pages in this manual. Do this for all page addresses required. Then put the lockout switch in its ON position. Now, if you select a page address, the meter will briefly confirm the chosen page address on screen, and will then function according to the settings you programmed for that address.

Suitable BCD coded switches are available from many electrical supply stores. For example consider Kraus & Naimer part A540-600 E24 or Apem part number IRBC10N1248 or London Electronics part number SW2P-8W-BCD, which also provides separate 2 pole 8 way signal selection function.

Error codes and fault finding



1. Under Range. The meter is being asked to display a value which is more negative than its limit of -199999



2. Over Range. The meter is being asked to display a value which is higher than its limit of 999999

If no loadcell is connected to the display, you will see one of these fault codes.

In addition, these fault codes could be displayed because the signal is too negative, too positive, or because there is a wiring error, or because the display's scaling has been adjusted to give excessive sensitivity, or because there is a fault in the display.

a. Measure the input signal on terminals 3(-) and 4(+) and confirm that it is between -40mV DC and +40mV DC. You can temporarily force the display's input signal to 0mV by wiring a link between terminal 3 and terminal 4, but keep the loadcell connected in addition to this link, as the display needs to see a full bridge at its input

b. Measure the excitation voltage on terminals 1(-) and 6(+) and confirm that it is between 9.5 and 10.5V DC. If it is less than 9.5V, remove the plug-in connector and measure the voltage directly on pins 1 and 6 with the connector removed. If it is still less than 9.5V, and if the meter has not been purposefully modified to give lower excitation, then there is most likely a fault with the display and it should be returned to us for the attention of our QA Manager, with a report of what you found, for repair.

c. Measure the sense voltage on terminals 2(-) and 5(+) and confirm that it is between 4 and 10.5V DC. If it is not, please confirm that you have connected terminal 1 to terminal 2 and terminal 5 to terminal 6, either at the meter end of the loadcell cable or at the loadcell end.

d. Measure the voltage between terminal 2(-) and terminal 3(+) It should be half of the voltage you measured in step 3. If it is not, there is most likely a wiring error between the display and the loadcell, or the loadcell is faulty. Check the wiring according to the installation instructions for the loadcell and the display. If that appears to be correct, measure the resistance of the four loadcell branches according to the loadcell manufacturer's specifications.

e. If steps 1 to 4 were satisfactory, the problem may be caused by the scaling being too sensitive. If you are happy to do so, it is a simple matter to reset the display's scaling to the factory default conditions. Put the lockout switch off and press all 4 buttons together for around 3 seconds until the display shows "dEFS n" press the UP button once so the display shows "dEFS Y". Now press the OK button and the display will be reset to factory defaults.

If still no success, please return the display to us for the attention of our QA Manager, with a report of what you found, for repair.

How to install option boards



Where the product is intended for “UL” installations removal or addition of option boards is not permitted.



Warning: Disconnect power before you expose the internals of the display

If you want to open your display to install or modify option boards, follow these steps...

- 1) Switch off power to the display and unplug all connectors.
- 2) Undo all the thumb screws on the rear case, store them safely and remove the back panel
- 3) Locate the main option board, which will be similar in appearance to the diagram below. If a main option board is absent, which will be the case if the display was ordered without any output options, then a main option board will need to be fitted.

The board assemblies will look like this...

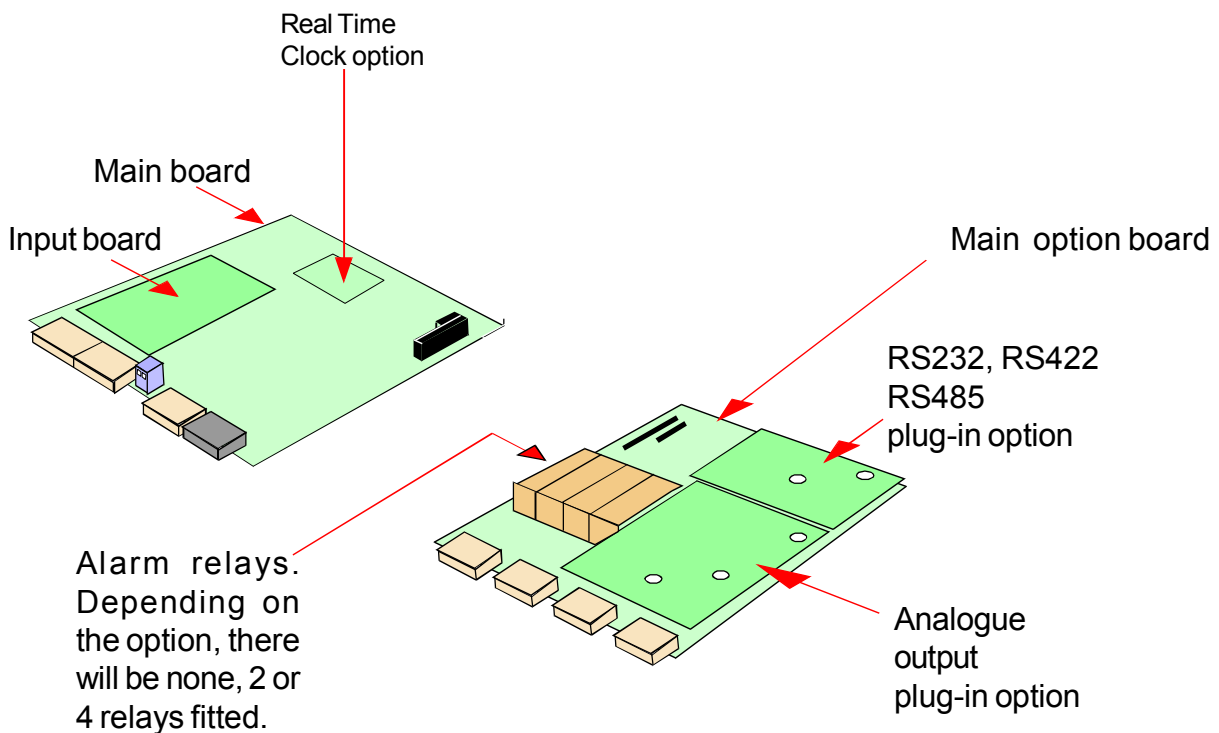

The analogue output and RS232 or RS422 plug-in option boards are fixed to the main option board with white plastic pillars. You must apply a firm force when fitting or removing these options.

Always be careful to connect the pins to sockets accurately. When reassembling, make sure option boards are firmly fixed to the upper option board.

Waste Electrical Electronic Equipment (WEEE)

In Europe, this equipment must be disposed of in accordance with European Parliamentary Directive 2002/96/EC

This directive encourages recycling and the reduction of waste materials in the environment.

This means it must be sent to an approved recycling plant if you want to dispose of it.

It must not be thrown away with general rubbish.



WEEE Waste Recycling

If you are unable to dispose of this item locally, you may send it to us for recycling.

Conditions:

1. We will only accept items of our manufacture.
2. You must pay for the transport of the goods to us.
3. We will only accept items if they include a signed declaration by an authorised person in your organisation, stating that :-
 - i. The item is safe to handle and has no contaminants which may be harmful to health.
 - ii. You wish us to dispose of or destroy the item(s)

Equipment Specifications

Case Material	Heavy duty welded uPVC
Connectors	Internal detachable Screw Terminal connectors accessed via compression glands
Environmental	Storage Temperature range -20 to +70C, non condensing. Allow 30 minutes for display to reach thermal equilibrium. Operating temperature range 0 to 50C. Internal heater option available for use in conditions down to -25C
Power Burden	100-240 VAC, 48 VAC, 45 to 60Hz or 11-30 VDC optional 40VA maximum
Sealing	IP65 all round, provided the display is mounted vertically and that all cable glands and rear case-closure screws are properly secured.
Input Signals (bipolar)	4 or 6 wire loadcell up to +/-40mV (+/- 100mV option)

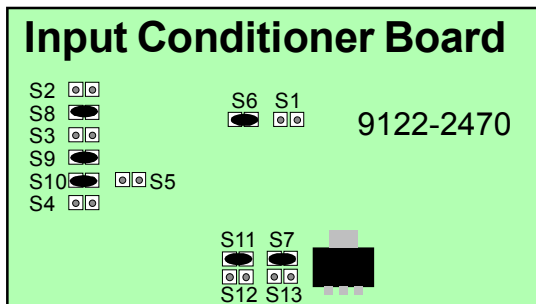

Default Input configuration switches

Link S8, S9, S10, S11. Open S2, S3, S4, S12, S13

Excitation voltages

5V DC Link S11. Open S7 and S12 and S13

10V DC Link S11 and S7. Open S12 and S13

Excitation Ratiometry

Ratiometric. Link S6. Open S1 (default)

Non ratiometric. Link S1. Open S6

Input Resistance	>10 Megohms
Accuracy	+/-0.05% of range
Span tempco	25 ppm/Degree Celsius
Zero Tempco	30 ppm/Degree Celsius
5V Excitation voltage	5VDC nominal rated at 40mA. Must connect to Sense.
10V Excitation voltage	10VDC nominal rated at 120mA. Must connect to Sense.
Excitation Sense	Ratiometric, 4V absolute minimum allowed after line drops
Filtering / smoothing	Selectable time constants of 0 to 25 seconds.
A/D conversion	Sigma-Delta 10 conversions per second, 50/60Hz rejection Resolution 1 in 400 000 max. over full range
Display update rate	10 readings per second.
Display Range (max)	-199999 to +199999, depending on available signal level.

Plug-In Output Options

Analogue, Alarm, Serial, Clock See separate manuals available from our website

Record of Revisions

17 November 2010	Version F00.19 Software released. Intended for use with 9122-2470 input board, having switched capacitor input filter feature. The newly released 9122-2470 input board allows selection of 5V or 10V excitation.
5 January 2011	Version F00.20 Software released. Allows serial data output to derived from Net or Gross measurement.
14 February 2011	Version F00.21 Software released. Added permanent segment test mode in bootup routine options. Warranty increased, terms added.
22 August 2011	Corrected Remote programmer connector details.

Loadcell connection notes

Important - Sense + and Sense - must always be referred to the excitation voltage. Never leave these terminals open.

Signal I/P & Excitation

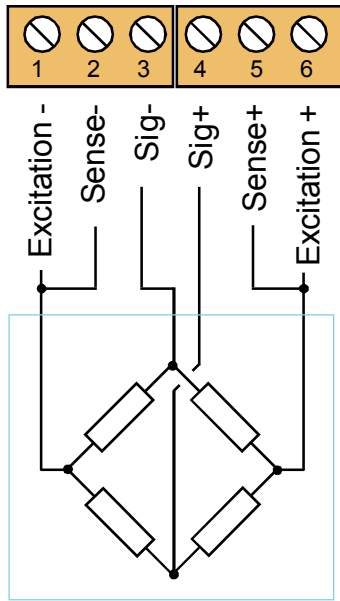

4 wire connection for short cable runs

Signal I/P & Excitation

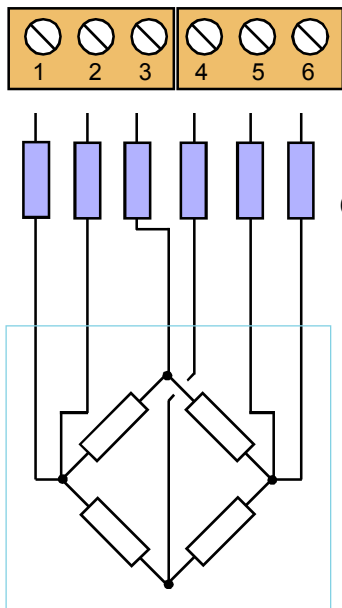

6 wire connection for long or high resistance cable runs

Cable and/or zener barrier resistance

Cable and/or zener barrier resistance must not cause the excitation voltage to drop below 4V.

NB If using galvanic isolation barriers, connect 10K from terminal 2 to terminal 3 and 10K from terminal 3 to terminal 5 to maintain the input signal within the common mode range of the excitation sense circuit.



Millivolt input only?

Link Exc+ to Sense+ and link Exc- to Sense-
Set Sig- to 5V using 2 x 10K resistors.

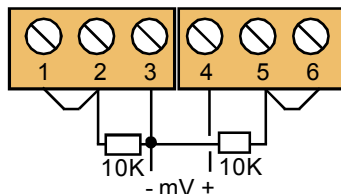

Declaration of CE Conformity

Declaration Reference : INTUITIVE Mk2
Issue Date : 30 April 2007
Products Covered : INTUITIVE Mk2 series
Title : DOC-INTUITIVE2

This is to confirm that the Product covered by this declaration has been designed and manufactured to meet the limits of the following EMC Standard :

EN61326-1:1997

and has been designed to meet the applicable sections of the following safety standards

EN61010-1:2001



Conditions

The meters are permitted a worst case error of 1% of A/D range during electro-magnetic disturbance, and must recover automatically when disturbance ceases without the need for human intervention, such as resetting, power-down etc.

The meters covered by this certificate must be installed in adherence to the following conditions :-

Signal cabling shall be routed separately to power carrying cabling (includes relay output wiring)

All signal cabling shall be screened. The screen shall only be terminated to the power earth terminal at the meter end of the cable.

Declared as true and correct, for and on behalf of London Electronics Ltd.

J.R.Lees Director